

# MAAX<sup>®</sup>

## SPAS

### INDUSTRIES CORP.

HOT TUB OWNER'S MANUAL





# ALERT

## **Your new spa's GFCI will trip.**

A Ground Fault Interrupter (GFCI) Trip Test must occur to allow proper spa function.

Spas that come with MXBP20 and MXBP501 control systems come with special instructions for the installer/electrician. If they have not already advised you on what to do or expect from the GFCI Trip Test, please contact them for instructions.

If the GFCI breaker connected to your spa trips, this is normal behavior. Please reset the breaker and enjoy your spa. The trip test has been completed successfully.

If your spa was not wired to a GFCI breaker or your breaker fails the GFCI Trip Test, the spa will repeatedly attempt (at preset intervals) to trip the breaker in the future until such time that it triggers a GFCI Trip. If a GFCI does not trip properly, your spa's display will show an error message.

GFCI breakers are important safety devices required by code for your hot tub. For more information, refer to the MXBP20 and MXBP501 sections of this manual or your local dealer.



# IMPORTANT SAFETY WARNINGS

## SAVE THESE INSTRUCTIONS

**WARNING:**

Children should not use spas or hot tubs without adult supervision.

**WARNING:**

Do not use spas or hot tubs unless all suction guards are installed to prevent body and hair entrapment.

**WARNING:**

Pregnant, or possibly pregnant, women should consult a physician before using a spa or hot tub.

**WARNING:**

People with infectious diseases should not use a spa or hot tub.

**WARNING:**

To avoid injury, exercise care when entering or exiting the spa or hot tub.

**WARNING:**

Do not use drugs or alcohol before or during the use of a spa or hot tub to avoid unconsciousness and possible drowning.

**WARNING:**

People using medications and/or having an adverse medical history should consult a physician before using a spa or hot tub.

**WARNING:**

Water temperature in excess of 100°F (38°C) may be injurious to your health.

**WARNING:**

Before entering the spa or hot tub, measure the water temperature with an accurate thermometer.

**WARNING:**

Do not use a spa or hot tub immediately following strenuous exercise.

**WARNING:**

Prolonged immersion in a spa or hot tub may be injurious to your health.

**WARNING:**

Maintain water chemistry in accordance with manufacturer's instruction.

**WARNING:**

Do not permit electric appliances (such as a light, telephone, radio or television) within 1.5m of the spa or hot tub.

**WARNING:**

The use of alcohol or drugs can greatly increase the risk of fatal hyperthermia in hot tubs and spas.

# TABLE OF CONTENTS

GFCI Alert.....	1	Temperature Controls.....	23
Important Safety Warnings.....	2	Modes of Operation.....	23
Table of Contents.....	3	Preset Filter Cycles.....	24
Important Safety Instructions.....	5	Changing Filter Cycles.....	24
Dos and Don'ts.....	7	Setting the Time.....	24
Hyperthermia.....	7	Light.....	24
Spa Installation.....	8	<b>501 Control Panel.....</b>	<b>25</b>
European Spas.....	8	Operating Instructions.....	25
Site and Positioning.....	8	User's Pads.....	26
Outdoor Installation.....	8	Temperature Controls.....	26
Indoor Installation.....	8	Jets.....	27
Spa System Components.....	9	Modes of Operation.....	27
Spa Components.....	10	Preset Filter Cycles.....	27
Jets and Air Controls.....	11	Changing Filter Cycles.....	27
Jets (Directional, Rotating, Euro).....	11	<b>504 Control Panel.....</b>	<b>29</b>
Cleaning or Replacing Jets.....	11	Operating Instructions.....	29
Cleaning the Jets.....	11	User's Pads.....	30
Air Controls.....	12	Temperature Controls.....	30
Electrical Information.....	13	Jets.....	30
Important Safety Instructions.....	13	Light.....	31
Ground-Fault Circuit Interruptor.....	13	Modes of Operation.....	31
Installation Options.....	13	Setting Filtration Cycles.....	31
Voltage/Amperage Charts.....	15	Preset Filter Cycles.....	31
Start Up Procedures.....	21	Changing Filter Cycles.....	32
Priming Your Spa.....	21	Clean Up Cycle.....	32
300 Control Panel.....	22	Bluetooth/MP3 Stereo Option.....	32
Operating Instructions.....	22	<b>TP600 Control Panel.....</b>	<b>34</b>
User's Pads.....	22	Main Menus.....	34
Temperature Controls.....	23	Filling Your Spa.....	35
Modes of Operation.....	23	Spa Behavior.....	35
Preset Filter Cycles.....	24	Temperature and Temp Range.....	36
Changing Filter Cycles.....	24	Mode - Rest and Ready.....	37
Setting the Time.....	24	Show and Set Time-of-Day.....	37
Light.....	24	Flip (Invert Display).....	37
<b>501 Control Panel.....</b>	<b>25</b>	Restricting Operation.....	38
Operating Instructions.....	25	Unlocking.....	38
User's Pads.....	26		
Temperature Controls.....	26		
Jets.....	27		
Modes of Operation.....	27		
Preset Filter Cycles.....	27		
Changing Filter Cycles.....	27		
<b>504 Control Panel.....</b>	<b>29</b>		
Operating Instructions.....	29		
User's Pads.....	30		
Temperature Controls.....	30		
Jets.....	30		
Light.....	31		
Modes of Operation.....	31		
Setting Filtration Cycles.....	31		
Preset Filter Cycles.....	31		
Changing Filter Cycles.....	32		
Clean Up Cycle.....	32		
Bluetooth/MP3 Stereo Option.....	32		
<b>TP600 Control Panel.....</b>	<b>34</b>		
Main Menus.....	34		
Filling Your Spa.....	35		
Spa Behavior.....	35		
Temperature and Temp Range.....	36		
Mode - Rest and Ready.....	37		
Show and Set Time-of-Day.....	37		
Flip (Invert Display).....	37		
Restricting Operation.....	38		
Unlocking.....	38		

Adjusting Filtration.....	38	Sanitizing With Ozone.....	55
Wi-Fi Connectivity.....	38	Specialty Chemicals.....	55
GFCI Trip Test.....	38	Draining Your Spa.....	55
<b>TP800 Control Panel.....</b>	<b>39</b>	Filter Maintenance.....	56
Button Functions.....	39	Winterizing.....	56
The Main Screen.....	40	Spa Cabinet Care.....	57
Spa & Shortcut Screens.....	40	Spa Surface Care and Cleaning.....	57
The Settings Screen.....	41	Light Bulbs.....	57
Filling Your Spa.....	42	<b>Common Water Problems.....</b>	<b>58</b>
Spa Behavior.....	43	<b>Common Hardware Problems.....</b>	<b>61</b>
Time-of-Day.....	43	<b>Spa Soaking Guidelines.....</b>	<b>63</b>
Adjusting Filtration.....	44	<b>300 Series System Wiring Diagram.....</b>	<b>64</b>
Restricting Operation.....	44	<b>501 Series System Wiring Diagram.....</b>	<b>65</b>
Unlocking.....	44	<b>504 Series System Wiring Diagram.....</b>	<b>66</b>
Wi-Fi Connectivity.....	44	<b>MXBP20 System Wiring Diagram.....</b>	<b>67</b>
GFCI Test Feature.....	45	<b>MXBP501 System Wiring Diagram.....</b>	<b>68</b>
Auxiliary Panel.....	45	<b>Safety sign.....</b>	<b>69</b>
Therapy Sequencer.....	45	<b>Limited Warranty Summary.....</b>	<b>69</b>
<b>WiFi Connectivity.....</b>	<b>48</b>	<b>Copyrights and Trademarks.....</b>	<b>70</b>
Smart Device WiFi Spa Controls.....	48	<b>Notes.....</b>	<b>71</b>
Getting Started.....	48		
After Application Download.....	48		
Connect to your Spa.....	48		
Connecting to WiFi Network.....	49		
Application Functions.....	50		
Settings.....	50		
Setting Time.....	50		
Setting Filter Cycles.....	51		
Controls.....	51		
<b>Equipment Safety Features.....</b>	<b>52</b>		
Automatic Time Outs.....	52		
Common LCD Equipment Messages.....	52		
Common LCD Messages.....	53		
<b>Maintenance.....</b>	<b>54</b>		
Water Chemistry.....	54		
Sanitizing.....	54		
pH Level.....	54		
Water Maintenance.....	54		

# IMPORTANT SAFETY INSTRUCTIONS

## READ AND FOLLOW ALL INSTRUCTIONS

- WARNING** - To reduce the risk of injury, do not allow children to use spa unless they are closely supervised at all times.
- A wire connector is provided on this unit to connect a minimum 6 AWG (5.15 mm<sup>2</sup>) solid copper conductor between this unit and any metal equipment, metal enclosures of electrical equipment, metal water pipe or conduit within 5 feet (1.5m) of the unit.
- (For cord-connected/convertible units)**  
**DANGER** - Risk of injury.
  - Replace damaged cord immediately.
  - Do not bury cord.
  - Connect to a grounded, grounding type receptacle only.
- DANGER** - Risk of Accidental Drowning. Extreme caution must be exercised to prevent unauthorized access by children. To avoid accidents, ensure that children cannot use this spa unless they are supervised at all times.
- DANGER** - Risk of injury. The suction fittings in this spa are sized to match the specific water flow created by the pump. If you must replace the suction fittings or the pump, be sure the flow rates are compatible. Never operate spa if the suction fittings are broken or missing. Never replace a suction fitting with one rated less than the flow rate marked on the original suction fitting.
- DANGER** - Risk of Electric Shock. Install at least 5 feet (1.5m) from all metal surfaces. As an alternative, a spa may be installed within 5 feet of metal surfaces if each metal surface is permanently connected by a minimum 6 AWG (5.15 mm<sup>2</sup>) solid copper conductor to the wire connector on the terminal box that is provided for this purpose.
- DANGER** - Risk of Electric Shock. Do not permit any electric appliance (such as a light, telephone, radio or television) within 5 feet (1.5m) of the spa.
- WARNING** - To reduce the risk of injury:
  - The water in a spa should never exceed 104°F (40°C).. Temperatures be tween 100°F (38°C) and 104°F (40°C) are considered safe for a healthy adult. Lower temperatures are recommended for young children and when spa use exceeds 10 minutes.
  - Since excessive water temperatures have a high potential for causing fetal damage during the early months of pregnancy, pregnant or possibly pregnant women should limit spa water temperatures to 100°F (38°C).
  - Before entering spa, measure the water temperature as water temperature regulating devices vary.
  - The use of alcohol, drugs, or medication before or during spa use may lead to unconsciousness with the possibility of drowning.
  - Obese persons and persons with a history of heart disease, low or high blood pressure, circulatory system problems, or diabetes should consult a physician before using a spa.

# SAVE ALL INSTRUCTIONS

**NOTE:** Check with your state/local code enforcement officer to determine electrical code requirements and compliance. Use a qualified licensed electrician to complete all final spa electrical connections.

**Caution: Risk of electrical shock. Read and follow all instructions.**

## TO AVOID RISK OF ELECTRICAL SHOCK:

1. A green colored terminal or a terminal marked G, GR, Ground, Grounding, or the international symbol  is located on the side of the supply terminal box or compartment. This terminal must be connected to the grounding means provided in the electric supply service panel, using a continuous copper wire equivalent in size to the circuit conductors supplying this equipment.  
*\*IEC Publication 417, Symbol 5019.*
2. At least two lugs marked "BONDING LUGS" are provided on the external surface or on the inside of the supply terminal box or compartment. Connect the local common bonding grid (house-hold ground) in the area of the hot tub or spa to these terminals, using an insulated or bare copper conductor not smaller than No. 6 AWG.
3. All field-installed metal components such as rails, ladders, drains or similar hardware located within 5 ft. of the spa or hot tub shall be bonded to the equipment grounding bus with copper conductors not smaller than No. 6 AWG.
4. **Never** connect unit to a power supply with a load controller.
5. Install to provide drainage of compartment for electrical components.
6. The electrical supply for this product must include a suitably rated switch or circuit breaker to open all ungrounded supply conductors. This disconnecting means must be readily accessible for operation but installed at least 1.5m from the spa. All electrical connections should comply with local regulations.

## DOS AND DON'TS OF SPA CARE

### Do:

- **Save these instructions!**
- Replace the cover immediately after use.
- Keep the cover locked when spa is not in use.
- Be aware of the dangers of a wet and slippery surface. Use caution when entering and exiting your spa.
- Have a licensed electrician make all final electrical connections.
- Replace worn, frayed or broken electrical cords.
- Keep the water chemistry correctly balanced. Untreated spa water will cause problems with your spa and equipment as well as being a health risk.
- Clean the spa filter monthly or as needed.
- Position the spa so that all sides remain accessible for maintenance.
- Use a bathing cap for long hair.
- Refer to information on hyperthermia.
- Use only authorized spa care products for the best performance and to keep the water properly balanced.

### Don't:

- Use the spa at 104°F (40°C) for long periods of time (more than 30 minutes).  
**See Hyperthermia**, next column.
- Use an extension cord to power your spa.
- Allow anyone to stand on the spa cover. It is not designed to support weight.
- Power the spa unless it is filled with water 5-6 inches below top of spa lip.
- Operate the pump on high speed for extended periods of time with the cover in place. Extended operation can cause heat build-up and interfere with spa operation.

### Hyperthermia

The causes, symptoms, and effects of hyperthermia may be described as follows: hyperthermia occurs when the internal temperature of the body reaches a level several degrees above the normal body temperature of 98.6°F (37°C). The symptoms of hyperthermia include an increase in the internal temperature of the body, dizziness, lethargy, drowsiness, and fainting. The effects of hyperthermia include:

- a. Failure to perceive heat
- b. Failure to recognize the need to exit spa or hot tub
- c. Unawareness of impending hazard
- d. Fetal damage in pregnant women
- e. Physical inability to exit the spa or hot tub, and
- f. Unconsciousness resulting in the danger of drowning

**WARNING** - The use of alcohol, drugs, or medication can greatly increase the risk of fatal hyperthermia.



# SPA INSTALLATION

The electrical supply for this product must include a suitably rated switch or circuit breaker to open all ungrounded supply conductors to comply with Section 422-20 of the National Electrical Code ANSI/NFPA70-1987. The disconnecting means must be accessible but installed at least 5 feet (1.5 m) from the spa water. All electrical connections should comply with article 680-D of the NEC.

## European Spas

The appliance should be supplied through a residual current device (RCD) with a rated tripping current not exceeding 30 mA. Means for disconnection must be incorporated in the fixed wiring in accordance with the wiring rules. Parts containing live parts, except parts supplied with safety extra-low voltage not exceeding 12 V, must be inaccessible to a person in the bath. Earthed appliances must be permanently connected to fixed wiring.

## Site and Positioning

Locate the spa on solid, level foundation or flooring, keeping in mind the weight of the filled spa (in excess of 1.800 kg on some models). If you have any doubts about the load bearing ability of your chosen site, contact an architect/building contractor. The entire perimeter of the spa cabinet and spa bottom must be evenly supported. If your spa is installed outdoors, we recommend you provide a concrete pad for the spa to rest on 8ft x 8ft x 4in (2.5m x 2.5m x 10cm).

**Failure to provide a level surface could structurally damage your spa and void the warranty.** The spa must be installed to allow access for service and maintenance on all four sides; therefore, below grade level installation is not recommended.

**Outdoor Installation,** Consider the following:

1. Local codes pertaining to fencing.
2. Local electrical and plumbing codes.
3. View from your house.
4. Wind direction.
5. Exposure to sunlight.
6. Distance to trees (twigs, leaves and shade).
7. Dressing and bathroom location.
8. Storage area for equipment and chemicals.
9. Location to facilitate adult supervision.
10. Landscaping and nighttime lighting.
11. Accessibility to equipment.
12. Power supply location and foot traffic.

**Indoor Installation,** Consider the following:

1. Indoor spas promote high humidity. Using ventilation fans or commercial grade dehumidifiers will help to reduce humidity.
2. **Floor drains must be provided near the spa to drain off water that may cause falls and/or water damage.**
3. Floor area should be flat with a non-skid finish. Carpeting is not recommended.
4. Walls/ceilings should be made of materials able to withstand high humidity.
5. Floor load bearing capacities must be able to support the concentrated spa weight.
6. Spas should be double checked for leaks before installing to avoid possible water damage. Dealer installation may include this service.
7. Indoor sun rooms can maintain high ambient temperatures which may effect the spa water temperature. It is NOT recommended that you operate your filter cycles for longer than 4 hours per day under these conditions.

**Danger: Electrical shock risk. Install at least 1.5m from all metal surfaces**

# SPA SYSTEM COMPONENTS



- A. Filter Skimmer/Weir:** Removes floating debris from the water surface, provides a water return path to equipment, and houses water filter element.
- B. Topside Control Panel:** Used to control temperature setting, pump for jets, and light.
- C. Air Controls:** Increases or decreases air entering the jets. Close during heating for maximum efficiency.
- D. Equipment Pack Service Panel (no user serviceable parts):** Spa support system consisting of 2-speed pumps, heater, and associated electrical controls are inside this front panel (not shown).
- E. Drain Access:** (Adjacent to the equipment service panel) Spa drain faucets.
- F. Digital/Fiber Optic Lighting:** Lighting system that displays multiple coloured lights in pre-programmed random, solid or alternating colors (not shown).
- G. Manufacturer's Identification Label:** Contains identification information for warranty service (serial number, model number, etc.) and electrical information (ampere rating and ampere requirements).
- H. Auxiliary Control:** Used to control jet pumps or stereo functions.
- I. Stereo/Speakers** (not shown).

# SPA COMPONENTS

Reference only. Equipment is not always as shown.

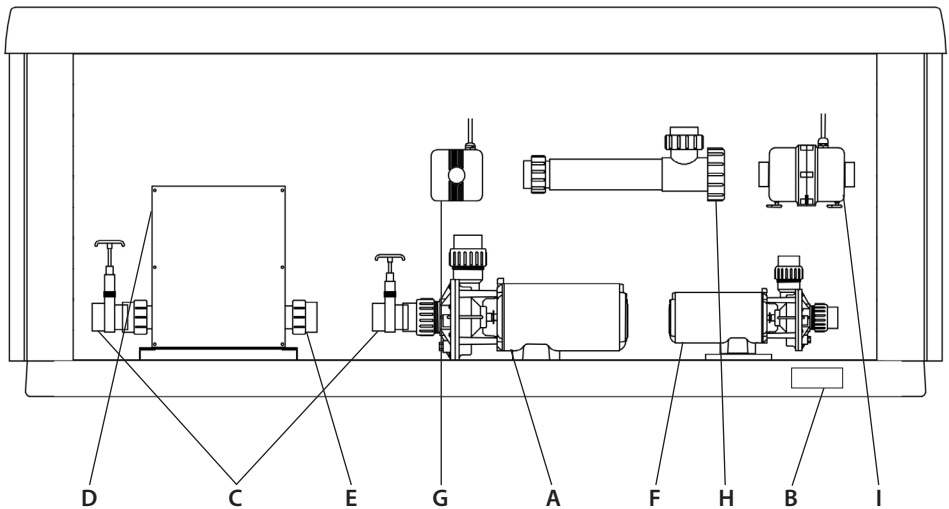

**A. Pumps (one pump or more, depending on model):** Low speed for efficient water circulation during filtration and heating; high speed for maximum action of the jets. The pump functions are activated by topside controls.

**B. Manufacturer's Identification Label:** Contains identification information for warranty service (serial number, model number, etc.) and electrical information (ampere rating and ampere requirements).

**C. Slice Valve:** Used to shut off water flow from the spa to the equipment while servicing. Quantity will vary depending on model. All should be open during normal operations.

**D. Electrical Connections:** Electrical inputs/wires for the unit connect here.

**E. Heater Assembly:** Thermostatically controlled and equipped with an overheat safety shut-off.

**F. Circ Pump (Optional)**

**G. Ozone Generator (Optional)**

**H. UV System (Optional)**

**I. Blower (Optional)**

**Note: Not consumer serviceable parts. Do NOT attempt to service any of these components yourself. Contact your dealer for assistance.**

# JETS AND AIR CONTROLS

## Jets

All spa jets are individually engineered to provide a unique hydro-massage. Depending on the model, your spa will have a combination of the following jets.

## Directional Jets

Positioned to focus on large muscle groups, these jets deliver a concentrated, high volume stream of water for a deep massage. Each jet is fully adjustable, allowing users to set the water flow to the most comfortable setting. Nozzle can be rotated to target sore muscles.

## Rotating Jets

Positioned to focus on muscle tension zones, these jets deliver a spinning V-shaped water stream for a gentle, pulsating massage. Each jet is fully adjustable, allowing for comfortable water flow settings for everyone to enjoy.

## Euro Jets

Positioned in the foot well or shoulder areas, these jets deliver a penetrating massage to dissolve tension. This jet may be the entry point for ozone produced during automatic filtration and therefore it is not adjustable.

**Note: Ozone production is stopped when functions are activated on control panel.**

## Cleaning or Replacing Jets

Hard water can cause calcium/mineral buildup that can restrict or bind the jets. A jet consists of a face plate and a nozzle. Rotate these parts weekly and remove/clean monthly to ensure free movement.

**NOTE: It is not necessary to drain the spa to clean or remove the jets.**

## Rotating Jets

- Rotate the jet face left and right
- Return face plate to full open position
- Turn the jets on high speed
- Twist the nozzle left and right
- Rotate the nozzle in the socket

**NOTE: If the jet insert disengages from the spa housing, see steps to reinstall below.**

## Cleaning Jets

- To **REMOVE** the jet insert, use the palm of your hand to exert pressure on the face of the jet. Turn counterclockwise until the jet 'clicks'. Gently pull the jet assembly from the housing.
- To **CLEAN** the jet insert and housing, use a pressurized hose and spray the inside of the jet. Soak the jet in a diluted spa cleaning solution, rinse. Wipe the inside of the housing to remove any debris.
- To **REINSTALL** the jet, line up the tab on the backside of the barrel with the groove in the body. Use the palm of your hand to gently tap the jet until it snaps into position.

**NEVER SHUT ALL FULL SIZED JETS OFF AT ONE TIME!**

## Air Controls

The intensity of the jet action can be controlled by altering the amount of air injected with water through the jets. Your spa has one or more air controls located on the lip of the spa. Each control activates air to specific jets in the spa allowing you to create various combinations and levels of jet action to suit individual preferences. Turn the control counter-clockwise to turn the air off and clockwise to turn air on.

**NOTE: Air controls should be closed during heating cycles for maximum energy efficiency.**

**NOTE: At the start of a filtration cycle, the Optional Air System is activated to purge the lines and ensure complete filtration. Ensure that at least one air control is always fully open.**

**On / Off Valve:** Turns on or shuts off the flow of water to multiple jets or the waterfall. This valve should be tested weekly to clean the lines and to help prevent debris build up.

**Diverter Valve:** Diverts water from one set of jets to another. This valve should be tested weekly to clean the lines and to help prevent debris build up.

**NOTE: The diverter and on / off valve(s) should be cleaned regularly.** Remove the handle by pulling upward and rocking it back and forth, unscrew the cap and pull the valve stem out. To **clean** the valve stem and housing, use a pressurized hose and spray the inside of the valve housing. Soak the valve stem in a diluted spa cleaning solution, rinse. Wipe the inside to remove debris.

# ELECTRICAL INFORMATION

## Important Safety Instructions

All electrical connections to this spa package **MUST** be done by qualified licensed electrician in accordance with National Electrical Code (NEC) and with state/local electrical codes in effect at the time of installation.

**NOTE: Prior to performing any service to the spa equipment, turn OFF all primary electrical power at the main circuit breaker or disconnect panel.**

To make spa electrical connections, remove the exterior equipment access panel, locate the electrical control box, remove the control box cover and follow the wiring diagram on the inside of the control box cover. **Connections should be made using copper conductors only.** Connecting wires, circuit breakers or fuses must all be sized to accommodate the Total Ampere load as specified on the equipment label.

This equipment is designed to operate on 60Hz alternating current only, at 240 volts or 120 volts, as required.

**NOTE: All unions must be hand-tight and all slice valves must be locked in the OPEN position before filling or refilling spa! A clip is provided to help keep the slice valve open. Run spa and check for union water leaks before reinstalling front panel.**

## Ground-Fault Circuit Interrupter

A qualified licensed electrician must connect the spa to a circuit protected by a GFCI. This is a requirement by the National Electric Code, article 680-42, and is also in compliance with Underwriter's Laboratories, Inc.

**Caution: Risk of electrical shock. Read and follow all instructions.**

## Installation Options

On some models, knockouts are provided in the cabinet base to bring the conduit to the equipment compartment. A hole may need to be drilled in the pedestal or base if an alternate electrical service entrance is desired. Refer to the manufacturer's nameplate located on the kick plate to determine your spa's ampere requirements.

**Note: Copper wire is strongly recommended for all electrical connections.**

Spas installed for 120 volt operation require a 3-wire, 40, 30, 20 or 15 amp., 120 volt sub-feed in non-metallic pipe to the spa equipment compartment (line 1, neutral and ground). A green colored terminal (or wire connector marked "G", or "GR", or "Grounding") is provided in the control box. To reduce the risk of electrical shock, connect this terminal or connector to the grounding terminal of your electrical service or supply panel with a continuous green insulated copper wire equivalent to the circuit conductor supplying this equipment, but no smaller than No. 12 AWG. A second pressure wire connector is provided on the surface of the control box for bonding to local ground points. To reduce the risk of electrical shock, this connector should be bonded with a No. 6 AWG copper wire to any metal ladders, water pipes, or any metal within 5 ft. of the spa.

Spas installed for 240 volt, 60 Hz, single phase operation require a 4-wire, 60, 50, 40 or 30 amp., 240 volt sub-feed in non-metallic pipe to the spa equipment compartment (line 1, line 2, neutral and ground). A green colored terminal (or wire connector marked "G", or "GR", or "Grounding") is provided in the control box. To reduce the risk of electrical shock, connect this terminal or connector to the grounding terminal of your electrical service or supply panel with a continuous green insulated copper wire equivalent to the circuit conductor supplying this equipment, but no smaller than No. 12 AWG. A second pressure wire connector is provided on the surface of the control box for bonding to local ground points. To reduce the risk of electrical shock, this connector should be bonded with a No. 6 AWG copper wire to any metal ladders, water pipes, or any metal within 5 feet of the spa.

## INSTRUCTIONS:

Find your spa listed within the charts on pages 16-20 of this manual then refer to the key below to determine what electrical service your spa requires.

240 Volt Installation Units Electrical Requirements	
Letter	Requirement
<b>A</b>	- 240 volt/60 amp. - 60 Hz - Single phase - 4-wire service (line 1, line 2 neutral and ground)
<b>B</b>	- 240 volt/50 amp. - 60 Hz - Single phase - 4-wire service (line 1, line 2, neutral and ground)
<b>C</b>	- 240 volt/40 amp. - 60 Hz - Single phase - 4-wire service (line 1, line 2, neutral and ground)
<b>D</b>	- 240 volt/30 amp. - 60 Hz - Single phase - 4-wire service (line 1, line 2, neutral and ground)

120 Volt Installation Units Electrical Requirements	
Letter	Requirement
<b>E</b>	- 120 volt/40 amp. - 60 Hz - Single phase - 3-wire service (line 1, neutral and ground)
<b>F</b>	- 120 volt/30 amp. - 60 Hz - Single phase - 3-wire service (line 1, neutral and ground)
<b>G</b>	- 120 volt/20 amp. - 60 Hz - Single phase - 3-wire service (line 1, neutral and ground)
<b>H</b>	- 120 volt/15 amp. - 60 Hz - Single phase - 3-wire service (line 1, neutral and ground)

Number	Meaning
<b>1</b>	The heater will remain running with pump(s) on high speed.
<b>2</b>	The heater can be activated only with the pump on low speed. Only the spa light can be operating at the same time without disabling the heater. See your authorized dealer to select this option.



## DEDICATED 240V UNITS WITHOUT BLOWER

Model	240V/60A	240V/50A	240V/40A	240V/30A
9000		B1	C2	
8500		B1	C2	
8000		B1	C2	
7500		B1	C2	
7000		B1	C2	
5600	A1		C2	
5400	A1		C2	
5300	A1		C2	
5200	A1		C2	
5100 (240V)			C1	D2
4600		B1		D2
4400		B1		D2
4200		B1		D2
4100			C1	D2
811	A1		C2	
781	A1		C2	
780	A1		C2	
581	A1		C2	
482	A1		C2	
481	A1		C2	
480	A1		C2	
472	A1		C2	
471	A1		C2	
470	A1		C2	
461	A1		C2	
451			C1	D2
381		B1	C2	
380		B1	C2	
371		B1	C2	
370		B1	C2	

See page 15 for explanation of corresponding letters and numbers.

## DEDICATED 240V UNITS WITHOUT BLOWER (continued)

Model	240V/60A	240V/50A	240V/40A	240V/30A
311		B1		D2
Amour		B1	C2	
Cabaret	A1		C2	
Chateau	A1		C2	
Elegant	A1		C2	
Envie	A1		C2	
ES	A1			
ESR	A1		C2	
ESX	A1		C2	
Fontaine	A1		C2	
Grand	A1		C2	
Intrigue		B1	C2	
Joli	A1		C2	
Monarque	A1		C2	
Mystique	A1		C2	
Nuage	A1		C2	
Prestige	A1		C2	
Rendezvous	A1		C2	
Trio			C1	D2

See page 15 for explanation of corresponding letters and numbers.

## DEDICATED 240V UNITS WITH BLOWER

Model	240V/60A	240V/50A	240V/40A	240V/30A
9000	A1		C2	
8500	A1		C2	
8000	A1		C2	
7500	A1		C2	
7000	A1		C2	
5600	A1		C2	
5400	A1		C2	
5300	A1		C2	
5200	A1		C2	
5100 (240V)		B1	C2	
4600	A1		C2	
4400	A1		C2	
4200	A1		C2	
4100		B1		D2
811	A1		C2	
781	A1		C2	
780	A1		C2	
581	A1		C2	
482	A1		C2	
481	A1		C2	
480	A1		C2	
472	A1		C2	
471	A1		C2	
470	A1		C2	
461		B1	C2	
451			C1	D2
381	A1		C2	
380	A1		C2	
371	A1		C2	
370	A1		C2	

See page 15 for explanation of corresponding letters and numbers.

## DEDICATED 240V UNITS WITH BLOWER (continued)

Model	240V/60A	240V/50A	240V/40A	240V/30A
311		B1		D2
Amour		B1	C2	
Cabaret	A1		C2	
Chateau	A1		C2	
Elegant	A1		C2	
Envie	A1		C2	
ES	A1			
ESR	A1		C2	
ESX	A1		C2	
Fontaine	A1		C2	
Grand	A1		C2	
Intrigue		B1	C2	
Joli	A1		C2	
Monarque	A1		C2	
Mystique	A1		C2	
Nuage	A1		C2	
Prestige	A1		C2	
Rendezvous	A1		C2	
Trio			C1	D2

See page 15 for explanation of corresponding letters and numbers.

## CONVERTIBLE UNITS WITHOUT GFCI CORD

Model	120V/40A	120V/20A	240V/50A	240V/40A
5100 (120V)	E1	G2	H1	C2
102	E1	G2	H1	C2
103	E1	G2	H1	C2
Cirque	E1	G2	H1	C2

**NOTE:** If you order the 5100 as a 120V model it leaves the factory as a 120V unit and can be converted up to 240 Volts. The 102, 103 and Cirque leave the factory as 240V units and can be converted down to 120 Volts. Electrical service requirements will change after conversion.

## CONVERTIBLE UNITS WITH GFCI CORD

Model	Cord Connected 120V/30A	Cord Connected 120V/15A	Cord Included 120V/30A	Cord Included 120V/15A
101			F1	H2
M50	F1	H2		
M61	F1	H2		
M71	F1	H2		
Duet			F1	H2
Image	F1	H2		
Forte	F1	H2		
Voeux	F1	H2		

**NOTE:** Units included in "Convertible Units with GFCI Cord" chart (above) leave the factory as 120V units and can be converted up to 240V units. See chart (below) "GFCI Cord Units After Conversion" for voltage and amperage requirements after conversion to a 240V unit.

## GFCI CORD UNITS AFTER CONVERSION

Model	240V/40A	240V/30A
101	C1	D2
M50	C1	D2
M61	C1	D2
M71	C1	D2
Duet	C1	D2
Image	C1	D2
Forte	C1	D2
Voeux	C1	D2

See page 15 for explanation of corresponding letters and numbers.

# START UP PROCEDURES

Follow recommendations for site location and electrical connection. The water line on the weir door is the level at which the water should be maintained.

1. Fill the spa through the filter hole to 6" (15.5cm) below the top of the spa with tap water. **Never use 'softened' water in your spa.** Softened water can impact the chemical balance of the water and lead to degradation of metal plumbing fittings and possible jet plastic damage.
2. Turn power on to unit at circuit breaker or disconnect panel.
3. Open the air controls, located on the top lip, and cycle the jets from high to low. Water should come from the therapy jets. If water flow is not established, turn off jets and see Priming Your Spa (next column).
4. Add chemicals. Ask your dealer for additional information.
5. Verify all drain valves are closed, some are under the spa.

Follow Operating Instructions for your particular model to set heat to the desired temperature. Initially you may find that the spa requires 12 to 14 hours on 230 Volt installations to reach temperature. Keep your thermal cover on the unit and close the air controls to help the heating process.

**Important: Do not operate the spa without full water flow.**

## Priming Your Spa

When filling your spa for the first time or after draining and refilling the spa, you may need to bleed air from the system. Should you experience an air-lock on Pump 1, remove the filter cover, insert a garden hose through each center hole that holds the filter as far as possible without using force. Hold the hose in place and turn on the water. Cycle pump 1 from low to high several times, this forces water into the pump and forces the air out. If this does not work or you experience an air-lock on Pump 2, remove the side panel and locate the pump. With the pump on high speed, slowly loosen the discharge (top) pump union until water starts to trickle out. Once water is trickling out, hand tighten the union (do not over tighten as this could cause the union to crack) and replace the side panel.

## Pr - This is Not an Error Message

The Spa has just been powered up and is in Priming Mode for 4 Minutes. Pumps can be turned ON and OFF to remove any air from the plumbing lines and the Heater. Cycle the pumps on and off to verify good water flow and wait 4 minutes or press any temp related button to exit Priming Mode.

# 300 CONTROL PANEL



Your Topside Control looks like this, your spa has the following features:

- Internal Light
- 1 Dual Speed Pump

**NOTE:** The look of your topside control panel design and buttons will vary according to brand. See table below for pictures and explanation of 300 Control Panel button functions.

The 300 Control System offers you simplicity in spa control. The backlit, Liquid Crystal Display (LCD) displays current temperature, set water temperature, and operating mode settings. Each feature is actuated through the control panel pad.

Touch the appropriate button to activate the desired function.

At start up, when power is supplied to the spa, the controls will operate properly and safely under the factory settings. The spa will be in **Standard** mode, have a temperature setting of 100°F (38°C), and a filtration cycle duration of 1 hour. To fully utilize the unique capabilities of the control system, it is important to know how to set the temperature, operate the pumps, operate the light, adjust the mode setting, and change the filtration cycle.

**Note:** In event of a power outage or failure, the 300 Series Control System may retain settings. If settings are lost, re-program per the instructions in this manual.

## User's Pads

User's Pads are the buttons located on the topside control panel and are used to program various spa functions (i.e., turn on spa light, set temperature, etc.). The following table defines the buttons:

Pad	Use
	<ul style="list-style-type: none"> <li>• Decrease temperature</li> <li>• Increase temperature</li> </ul>
	<ul style="list-style-type: none"> <li>• Switch modes</li> <li>• Change filter cycle durations</li> </ul>
	<ul style="list-style-type: none"> <li>• Turn internal spa light on or off</li> <li>• Switch modes</li> </ul>
	<ul style="list-style-type: none"> <li>• Activate therapy pump</li> <li>• Set duration of filter cycles</li> </ul>

## Temperature Controls

The maximum set temperature is 104°F (40°C) and the minimum set temperature is 80°F (26°C). The current water temperature or, if the pump has not been running, two dashes, will show on the display. If dashes are displayed, you must first start the pump by pressing the **PUMP 1** pad. Wait until the water temperature is displayed (approximately 1 minute).

The set temperature of your spa may easily be increased or decreased at any time using the **'TEMP'** pad. Press the **'TEMP'** pad; the set temperature will be displayed in the LCD window. The next touch of **'TEMP'** will change the set temperature either up or down 1°F (0,5°C). If you want to increase the temperature and the displayed indicates the temperature was increased by 1°F (0,5°C), continue to press the **'TEMP'** pad until the desired set temperature is reached.

If you want to decrease the set temperature and the LCD indicates that the temperature is increasing, **STOP**. Wait a few seconds until the actual temperature is displayed. Then press the **'TEMP'** pad again. The set temperature will be displayed. Press it again and the set temperature will decrease by 1°F (0,5°C). Continue pressing the **'TEMP'** pad until the desired set temperature is reached. If the spa is set in Standard mode or in a filtration cycle, increasing the set temperature may result in activating the heater. Decreasing the set temperature will turn the heater off. When the heater is operating, the LED below the **'HEAT'** icon will be lit.

### Pump 1

Touch the **'JETS'** pad to activate the primary filtration pump. The sequence of the jet action is:

- 1 touch = Low therapy jets
- 2 touches = High therapy jets
- 3 touches = Off

The low speed operation of Pump 1 is timed to automatically turn off after two hours of operation. The high speed operation of Pump 1 is timed to automatically turn off after 15 minutes of operation.

**NOTE: With the standard configuration, pump 1 will automatically operate in low speed whenever the spa calls for a filtration cycle or heat. When this automatic activation occurs, the low speed of Pump 1 cannot be turned off; however, all other control functions can be activated.**

### MODES OF OPERATION:

In the standard configuration your spa can be switched among **Standard**, **Economy**, and **Sleep modes** by touching the **'TEMP'** pad and then the **'LIGHT'** pad.

If your spa is in the

#### **Standard mode**,

the low speed of Pump 1 and the heater will come on automatically to maintain the set temperature of the water. The pump will circulate for approximately one minute several times throughout the day to sample water temperature. If your spa is set in:

#### **Economy mode**,

the heater will operate **ONLY** during the filtration cycles. If your spa is set in the

#### **Sleep mode**,

the spa will heat to within 20°F (11°C) of the set temperature only during filter cycles.

The pump will operate either during a normal filtration cycle or, the heater and pump will be activated when the heater housing temperature drops below 45°F (7.2°C).

The selected mode will be displayed in the LCD window of the control panel.



When in **Standard mode**, the letters 'ST' are displayed briefly, followed by the water temperature. When in **Economy mode**, the letters 'EC' are displayed alternately with the water temperature.

When in **Sleep mode**, the letters 'SL' are displayed alternately with the water temperature.

### Setting the Time and Filtration Cycles

You can decide when your filter cycles start and how long they run.

**Preset Filter Cycles.** The spa control system is designed with two filter cycles. The first filter cycle turns on 6 minutes after power is supplied to the spa. The second filter cycle turns on 12 hours later. Filter cycles are pre-set for a two hour duration.

**Note: To properly clean and maintain spa, a total filter time of at least two hours per day is recommended. If an ozonator is installed, 4 hours is recommended.**

### Changing Filter Cycle Start Time

The start/stop times of the filter cycle correspond to 6 minutes after the spa set time is established. Set time is based on the time of day that the spa is powered up. Set time may only be changed by disconnecting power from the spa and re-connecting it at the desired start time. For example, if you want the filter cycle to begin at **9:00 PM**, turn off the spa breaker and turn it back on at **8:54 PM** (remember the 6 minute wait period). The cycle will begin at **9:00 PM** and will repeat beginning at **9:00 AM**. Each cycle will run for the prescribed number of hours.

### Changing Filter Cycle Duration

The duration of a filter cycle can be set in one

hour increments of 1- 8. For example, a 2 hour cycle will complete once every 12 hours for a total of 4 hours per day. The amount of time needed to filter your spa will depend on usage and ambient conditions.

You will need to program your filter cycles based upon your personal use.

To change the duration of the filter cycles touch the 'TEMP' pad and then touch the 'JETS' pad. Touch the 'TEMP' pad to adjust the cycle duration to the desired setting. After each press, the duration of the cycle will be displayed in the LCD window as follows:

**F1** 1 Hours for each cycle, 2 hours per day

**F2** 2 Hours for each cycle, 4 hours per day

**F3** 3 Hours for each cycle, 6 hours per day

**F4** 4 hours for each cycle, 8 hours per day

**F5** 5 hours for each cycle, 10 hours per day

**F6** 6 Hours for each cycle, 12 hours per day

**F7** 7 Hours for each cycle, 14 hours per day

**F8** 8 Hours for each cycle, 16 hours per day

To exit the filter-set procedure, touch 'JETS'.

The LCD window will display the current water temperature.

If a change is made to the duration while the spa is in a filtration cycle, it will take effect immediately. If the change is made outside a filtration cycle, it will take effect at the start of the next scheduled cycle.

**NOTE: When power to the spa is denied (disconnect, power outage), the controls may revert to the default factory settings. Any adjustments to set temperature or filter cycle duration may need to be reprogrammed.**

### Light

Touch the 'LIGHT' pad to turn all lights on and off. The lights will automatically turn off after 4 hours of operation.

# 501 CONTROL PANEL



If your Topside Control looks like this, your spa has the following features:

- Internal Lights
- 1 Pump 2 speed



If your Topside Control looks like this, your spa has the following features:

- Internal Lights
- 1 Pump 2 speed
- Blower

**NOTE:** The look of your topside control panel design and buttons will vary according to brand. See next page for pictures and explanation of 501 Control Panel button functions.

The 501 Controls offer you simplicity in spa control. The backlit, Liquid Crystal Display (LCD) displays current temperature, set water temperature, and operating mode settings. Each feature is actuated through the control panel pad.





Touch the appropriate button to activate the desired function.

At start up, when power is supplied to the spa, the controls will operate properly and safely under the factory settings. The spa will be in **Standard** mode, have a temperature setting of 100°F (38°C), and a filtration

cycle duration of 2 hours. To fully utilize the unique capabilities of the control system, it is important to know how to set the temperature, operate the pumps, operate the light, adjust the mode setting, and change the filtration cycle durations.

## User's Pads

User's Pads are the buttons located on the topside control panel and are used to program various spa functions (i.e., turn on spa light, set temperature, etc.). The following table defines the buttons:

Pad	Use
	<ul style="list-style-type: none"> <li>• Decrease temperature</li> <li>• Increase temperature</li> <li>• Change filter durations</li> </ul>
	<ul style="list-style-type: none"> <li>• Turn internal spa light on or off</li> <li>• Switch modes</li> <li>• Set duration of filter cycles</li> </ul>
	<ul style="list-style-type: none"> <li>• Activate therapy pump</li> </ul>
	<ul style="list-style-type: none"> <li>• Optional</li> <li>• Turns blower system on or off</li> <li>• Same as Turbo</li> </ul>

## Temperature controls

The maximum set temperature is 104°F (40°C) and the minimum set temperature is 80°F (26°C). The current water temperature or, if the pump has not been running, two dashes, will show on the display. If dashes are displayed, you must first start the pump by pressing the **JETS** pad. Wait until the water temperature is displayed (approximately 2 minutes).

The set temperature of your spa may easily be increased or decreased at any time using the **'TEMP'** pad. Either the actual temperature or 2 dashes will be displayed. Press the **'TEMP'** pad; the set temperature will be displayed in the LCD window. The next touch of **'TEMP'** will change the set temperature either up or down 1°F (0,5°C). If you want to increase the temperature and the displayed indicates the temperature was increased by 1°F (0,5°C), continue to press the **'TEMP'** pad until the desired set temperature is reached.

If you want to decrease the set temperature and the LCD indicates that the temperature is increasing, **STOP**. Wait a few seconds until the actual temperature is displayed. Then press the **'TEMP'** pad again. The set temperature will be displayed. Press it again and the set temperature will decrease by 1°F (0,5°C). Continue pressing the **'TEMP'** pad until the desired set temperature is reached.

If the spa is set in Standard mode or in a filtration cycle, increasing the set temperature may result in activating the heater. Decreasing the set temperature will turn the heater off. When the heater is operating, the LCD indicator below the **'TEMP'** icon will be lit.

## JETS

Touch the 'JETS' pad to activate the primary filtration pump. The sequence of the jet action is:

- 1 touch = Low therapy jets
- 2 touches = High therapy jets
- 3 touches = Off

The low speed operation of Pump 1 is timed to automatically turn off after two hours of operation. The high speed operation of Pump 1 is timed to automatically turn off after 15 minutes of operation.

**NOTE: Pump 1 will automatically operate in low speed whenever the spa calls for a filtration cycle or heat. When this automatic activation occurs, the low speed of Pump 1 cannot be turned off; however, all other control functions can be activated.**

### Standard/Economy/Sleep Modes

Your spa can be switched among **Standard**, **Economy**, and **Sleep modes** by touching the 'TEMP' pad and then the 'LIGHT' pad.

If your spa is in the **Standard** mode, the low speed op Pump 1 and the heater will come on automatically to maintain the set temperature of the water.

If your spa is set in the **Economy mode**, the heater will operate **ONLY** during the filtration cycles. The pump will circulate for approximately two minutes several times throughout the day to sample water temperature.

If your spa is set in the **Sleep mode**, the heater and pump will operate either during a filtration cycle or, when the heater housing temperature drops below 45°F (7,2°C). The spa will heat to within 20°F (11°C) of the set temperature only during filter cycles.

The selected mode will be displayed in the LCD window of the control panel.

When in **Standard mode**, the letters 'ST' are displayed, followed by the water temperature. When in **Economy mode**, the letters 'EC' are displayed alternately with the water temperature. When in **Sleep mode**, the letters 'SL' are displayed alternately with the water temperature.

## Setting the Time and Filtration Cycles

**Preset Filter Cycles.** The spa control system is designed with two filter cycles. The first filter cycle turns on 6 minutes after power is supplied to the spa. The second filter cycle turns on 12 hours later. Filter cycles are pre-set for a two hour duration.

**NOTE: To properly clean and maintain spa, a total filter time of at least four hours per day is recommended.**

### Changing Filter Cycle Start Time

The start/stop times of the filter cycle correspond to 6 minutes after the spa set time is established. Set time is based on the time of day that the spa is powered up. Set time may only be changed by disconnecting power from the spa and re-connecting it at the desired start time. For example, if you want the filter cycle to begin at **9:00 PM**, unplug the spa and re-connect it at **8:54 PM** (remember the 6 minute wait period). The cycle will begin at **9:00 PM** and will repeat beginning at **9:00 AM**. Each cycle will run for the prescribed number of hours.

## Changing Filter Cycle Duration

The duration of a filter cycle can be set in hour increments of 2, 4, 6, 8, or continuous. For example, a 2 hour cycle will complete once every 12 hours for a total of 4 hours per day. The amount of time needed to filter your spa will depend on usage and ambient conditions. You will need to program your filter cycles based upon your personal use.

To change the duration of the filter cycles touch the 'TEMP' pad and then touch the 'JETS' pad. Touch the 'TEMP' pad to adjust the cycle duration to the desired setting. After each press, the duration of the cycle will be displayed in the LCD window as follows:

**F2** 2 Hours for each cycle, 4 hours per day

**F4** 4 Hours for each cycle, 8 hours per day

**F6** 6 Hours for each cycle, 12 hours per day

**F8** 8 hours for each cycle, 16 hours per day

**FC** Continuous filtration, 24 hours per day

To exit the filter-set procedure, touch 'JETS'. The LCD window will display the current water temperature.

If a change is made to the duration while the spa is in a filtration cycle, it will take effect immediately. If the change is made outside a filtration cycle, it will take effect at the start of the next scheduled cycle.

**NOTE: When power to the spa is denied (disconnect, power outage), the controls may revert to the default factory settings. Any adjustments to set temperature or filter cycle duration may need to be reprogrammed.**

# 504 CONTROL PANEL

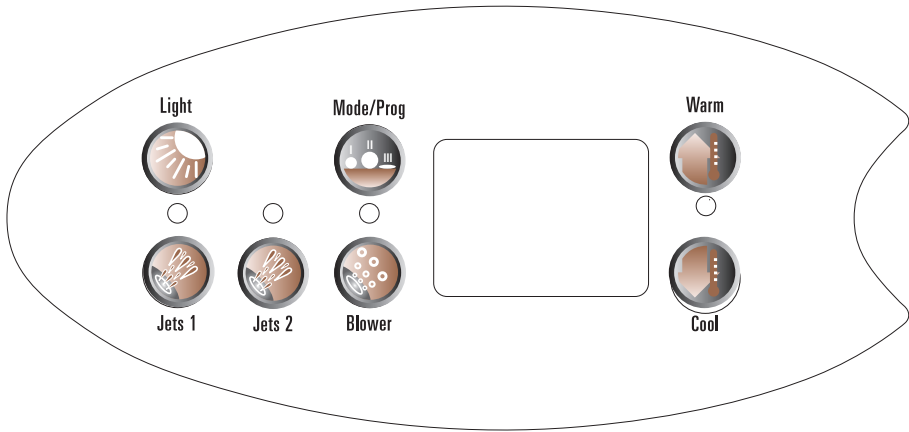

**NOTE:** The look of your topside control panel design and buttons will vary according to brand and features available on your spa. See table on next page for pictures and explanation of 504 Control Panel button functions.







The 504 Series Control Panel offers you advanced spa control. The backlit, Liquid Crystal Display (LCD) displays current water temperature, set point water temperature and operating mode settings. Each feature of the system is actuated through a control panel touch pad. Touch the appropriate pad to activate the desired function.

At start up, when power is supplied to the spa, the controls will operate properly and safely under the factory settings. The spa will be in **Standard** mode, have a temperature setting of 100°F (38°C), and a filtration cycle duration of 2 hours. To fully utilize the unique capabilities of the control system, it is important to know how to set the temperature, operate the pumps, operate the light, adjust the mode setting, and change the filtration cycles.

**Note:** In event of a power outage or failure, the 504 Series Control Panel should retain all settings. If settings are lost, re-program per the instructions in this manual and contact your dealer.

## User's Pads

User's Pads are the buttons located on the topside control panel and are used to program various spa functions (i.e., turn on spa light, set temperature, etc.). The following table defines the pads:

Pad	Use
	<ul style="list-style-type: none"> <li>• Increase temperature</li> <li>• Change time settings</li> </ul>
	<ul style="list-style-type: none"> <li>• Decrease temperature</li> <li>• Change time settings</li> </ul>
	<ul style="list-style-type: none"> <li>• Switch heating modes</li> </ul>
	<ul style="list-style-type: none"> <li>• Turn internal spa light on or off</li> </ul>
	<ul style="list-style-type: none"> <li>• Optional. Turns blower system on or off. Same as Turbo</li> </ul>
	<ul style="list-style-type: none"> <li>• Activate primary filtration pump</li> </ul>
	<ul style="list-style-type: none"> <li>• Activate therapy pump</li> </ul>

## Temperature Controls

The maximum set temperature is 104°F (40°C) and the minimum set temperature is 80°F (26°C). The current water temperature or, if the pump has not been running, two dashes, will show on the display. If dashes are displayed, you must first start the pump by pressing the 'JETS 1' pad. Wait until the water temperature is displayed (approximately 2 minutes). The set temperature of your spa may easily be

increased or decreased at any time using the 'UP' or 'DOWN' pads. When either of these pads is touched, the set temperature will be displayed in the LCD window. Each successive touch will change the set temperature 1°F (0.5°C) in the chosen direction. After 3 seconds the LCD will automatically display the water temperature or dash lines.

If the spa is set in Standard mode or in a filtration cycle, adjusting the set temperature may result in activating the heater. When the heater is operating, the heat icon will be displayed in the LCD.

**Note: 230-Volt spas that are wired with the low Amp option will not heat when Pump 1 is on in high speed, or when Pump 2 is in operation.**

### JETS 1

Touch the 'JETS 1' pad to activate the primary filtration pump. The sequence of the jet action is:

- 1 touch = Low jets
- 2 touches = High jets
- 3 touches = Off

### JETS 2

Touch the 'JETS 2' pad to activate the therapy pump. The sequence of jet action is:

- 1 touch = High jets
- 2 touches = Off

The low speed operation of Pump 1 is timed to automatically turn off after 2 hours of operation. The high speed operation of Pump 1 and the high speed operation of Pump 2, are timed to automatically turn off after 15 minutes of operation.

**Note: Pump 1 will automatically operate in low speed whenever the spa calls for a filtration cycle or heat. When this automatic activation occurs, the low speed of Pump 1 cannot be turned off; however, all other control functions can be activated.**

### Light

Touch the 'LIGHT' pad to turn the internal spa light on and off. The spa light will automatically turn off after 1 hour of operation.

### Operating Modes

Your spa comes with three primary operating modes.

**Standard Mode** maintains the water at the desired set temperature. Note that the last measured spa temperature displayed is current only when the pump has been running for at least 2 minutes. The 'STD' icon will be displayed in the LCD window when this mode is selected.

**Economy Mode** heats the water to the desired set temperature **ONLY** during filter cycles. The 'ECN' icon will be displayed in the LCD window when this mode is selected. While in the Economy mode, pressing the 'JETS 1' button will put the spa into the **Standard-In-Economy** mode, which operates the same as the Standard Mode, then reverts back to the Economy mode after 1 hour. The spa can be immediately reverted back into the Economy mode at any time by simply pressing the 'MODE' button.

**Sleep Mode** heats the spa to within 20°F (11°C) of the set temperature only during filter cycles. The 'SLP' icon will be displayed in

the LCD window when this mode is selected. The heater will also come on when the heater housing temperature drops below 45°F (7,2°C).

When in **Standard mode**, the letters 'STD' are displayed, followed by the water temperature. When in **Economy mode**, the letters 'ECN' are displayed alternately with the water temperature. When in **Sleep mode**, the letters 'SLP' are displayed alternately with the water temperature.

### Changing Modes

To change the operating mode, press the 'UP' or 'DOWN' and then press the 'MODE' button. The operating mode will be flashing on the LCD window. Press the 'DOWN' button to cycle through to the desired mode, and then press the 'MODE' button to confirm selection.

### Filtration Cycles

The control system on your spa has been designed to function properly and safely at 104°F (40°C) after connecting the electrical wires and installing the proper grounds. To take full advantage of the unique capabilities of your new spa, you should first establish your filtration cycle durations.

### Setting the Filtration Cycles

#### Preset Filter Cycles

The spa control system is designed with two filter cycles. The first filter cycle turns on 6 minutes after power is supplied to the spa. The second filter cycle begins 12 hours later. Filter cycles are pre-set for a two hour duration.

**Note: To properly clean and maintain spa, a total filter time of at least four hours per day is recommended.**



### Changing Filter Cycle Start Time

The start/stop times of the filter cycle correspond to 6 minutes after the spa set time is established. Set time is based on the time of day that the spa is **powered up**. Set time may only be changed by disconnecting power from the spa and reconnecting it at the desired start time. For example, if you want the filter cycle to begin at **9:00 PM**, unplug the spa and re-connect it at **8:54 PM** (remember the 6 minute wait period). The cycle will begin at **9:00 PM** and will repeat beginning at **9:00 AM**. Each cycle will run for the prescribed number of hours.

### Changing Filter Cycle Duration

The duration of a filter cycle can be set in two hour increments of 2, 4, 6, 8, or continuous. For example, a 2 hour cycle will complete once every 12 hours for a total of 4 hours per day. The amount of time needed to filter your spa will depend on usage and ambient conditions. You will need to program your filter cycles based upon your personal use.

To change the duration of the filter cycles press the **'UP'** or **'DOWN'** button and then touch the **'JETS 1'**.

Press the **'UP'** or **'DOWN'** button to adjust the cycle duration to the desired setting. After each press, the duration of the cycle will be displayed in the LED window as follows:  
**F2** 2 Hours for each cycle, 4 hours per day  
**F4** 4 Hours for each cycle, 8 hours per day  
**F6** 6 Hours for each cycle, 12 hours per day  
**F8** 8 hours for each cycle, 16 hours per day  
**FC** Continuous filtration, 24 hours per day  
 To exit the filter-set procedure, touch **'JETS 1'**. The LED window will display the current water temperature.  
 If a change is made to the duration while the

spa is in a filtration cycle, it will take effect immediately. If the change is made outside a filtration cycle, it will take effect at the start of the next scheduled cycle.

**Note: When power to the spa is denied (disconnect, power outage), the controls may revert to the default factory settings. Any adjustments to set temperature or filter cycle duration may need to be reprogrammed.**

**Note: At the start of each filtration cycle, Pump 2 and Air Blower (if installed) are activated for 30 seconds to clear the water in the pipes and ensure complete filtration.**

### Clean Up Cycle

After periods of heavy use, you can manually start a clean-up cycle by turning Pump 1 on in low speed. The pump will operate for 2 hours and then automatically turn off. The heater can also operate during this period if the controls are set in the Standard mode.

### Bluetooth/MP3 Stereo Option

**CAUTION: Stereo/MP3/Cell Phone/Portable Electronic Devices**

**Many consumers own some form of portable electronic device, and some spas come equipped with stereos designed to interface with these devices. It is important to protect a spa's stereo equipment and your portable electronics by following a few simple procedures:**

- Always turn the volume down on your portable electronic device before connecting it to the spa stereo.
- Do not attempt to handle any portable electronic device with wet hands.
- Inspect any area for moisture before setting your portable electronic device in or on it.



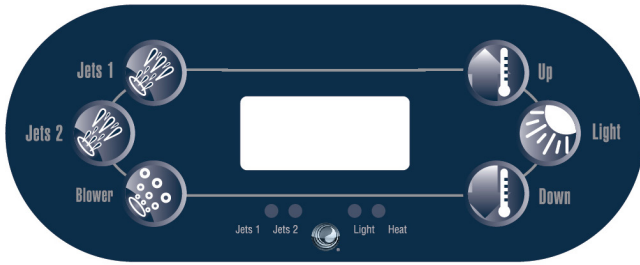

- Because of the temperature differential between the warm spa cabinet interior and cooler surroundings outside, moisture is a distinct possibility inside built-in niches. Be sure to wipe these areas out with a dry cloth before connecting any portable electronic device, and do not leave the device inside the niche after exiting the spa.

- Water-resistant covers are available for many popular cell phones and portable music players. These covers are a wise investment for individuals who regularly use their portable electronic devices near hot tubs.

# TP600 CONTROL PANEL



**NOTE:** The look of your topside control panel design and buttons will vary according to brand and features available on your spa. See table below for pictures and explanation of TP600 Control Panel button functions.

BUTTON	NAME	FUNCTION
	Jets 1 Jets 2	Activates jets on low or high setting
	Blower	Activates blower
	Temperature Up	Increases temperature and allows for navigation through system
	Temperature Down	Decreases temperature and allows for navigation through system
	Light	Activates lights and chooses menus to navigate through system

## MAIN MENUS

### NAVIGATION

Navigating the entire menu structure is done with 3 buttons on the control panel: Temperature Up, Temperature Down and Light buttons.

Panels have separate **WARM** (Up) and **COOL** (down) buttons which are used to increase or decrease the temperature. These buttons are also used to navigate through menus.

The **LIGHT** button is used to activate spa lights and is also used to choose various menus to navigate each section.

Typical use of the Temperature buttons allows changing the Set Temperature while the numbers are flashing in the LCD screen.

Numbers will begin flashing when either one of the temperature buttons are pressed. Pressing the **LIGHT** button while the numbers are flashing will take you to the menus.

The menus can be exited with certain button presses. Simply waiting for several seconds will return the panel operation to normal.

## FILLING YOUR SPA

### PREPARATION AND FILLING

Fill the spa 5-6" below the lip of the spa. Open all valves and jets in the plumbing system before filling to allow as much air as possible to escape from the plumbing and the control system during the filling process.

### PRIMING MODE

This mode will last 4-5 minutes or you can manually exit the priming mode after the pump(s) have primed. Regardless of whether the priming mode ends automatically or you manually exit the priming mode, the system will automatically return to normal heating and filtering at the end of the priming mode. During the priming mode, the heater is disabled to allow the priming process to be completed without the possibility of energizing the heater under low-flow/no-flow conditions. Nothing comes on automatically, but the pump(s) can be energized by pushing the "Jet" buttons. If the spa has a Circ Pump, it can be activated by pressing the "Light" button during Priming Mode.

### PRIMING THE PUMPS

After the display has gone through screens: "RUN" "PMPS" "PURG" "AIR" "-- -- -- --", push "Jet" button once to start Pump 1 in low-speed and again to switch to high-speed. Push the Pump 2 button (if you have a 2nd pump) to turn it on. The pumps will not be running in high-speed to facilitate priming. If the pumps have not primed after 2 minutes, and water is not flowing from the jets in the spa, turn off the pumps and repeat.

NOTE: Turning the power off/on again will initiate a new pump priming session. Sometimes turning the pump off/on helps it to prime. If the pumps will not prime after 5 times, turn power off and call for service.

IMPORTANT: A pump should not be allowed to run without priming for more than 2 minutes. Under NO circumstances should a pump be allowed to run without priming beyond the end of the 4-5 minute priming mode. Doing so may cause damage to the pump and cause the system to energize the heater and go into an overheat condition.

### EXITING PRIMING MODE

Manually exit Priming Mode by pressing either Temperature button. If you do not manually exit the priming mode, it will be automatically terminated after 4-5 minutes. Be sure that the pump(s) have been primed by this time. Once the system has exited Priming Mode, the top-side panel will momentarily display the set temperature but the display will not show the temperature yet because the system requires approximately 1 minute of water flowing through the heater to determine the water temperature and display it accurately.

## SPA BEHAVIOR

### Pumps

Press the "Jets 1" button once to turn pump 1 on or off, and to shift between low- and high-speeds if equipped. If left running, the pump will turn off after a time-out period. The pump 1 low-speed will time out after 30 minutes. The high-speed will time out after 15 minutes. On non-circ systems, the low-speed of pump 1 runs when the blower or any other pump is on. If the spa is in Ready Mode, Pump 1 low may also activate for at least 1 minute every 30 minutes to detect the spa temperature and then to heat to the set temperature if needed. When the low-speed turns on automatically, it cannot be deactivated from the panel, however the high speed may be started.

### Circulation Pump Modes

The circ pump (if your spa is equipped with one) operates continuously (24 hours) with the exception of turning off for 30 minutes at a time when the water temperature reaches 3°F (1.5°C) above the set temperature (most likely to happen in very hot climates).

### Filtration and Ozone

On non-circ systems, Pump 1 low and the ozone generator will run during filtration. On circ systems, the ozone will run with the circ pump.

The system is factory-programmed with one filter cycle that will run in the evening (assuming the time-of-day is properly set) when energy rates are often lower. The filter time and duration are programmable. A second filter cycle can be enabled as needed. At the start of each filter cycle, the blower (if there is one) or Pump 2 (if there is one) will run briefly to purge its plumbing to maintain good water quality.

### Freeze Protection

If the temperature sensors within the heater detect a low enough temperature, the pump(s) and the blower automatically activate to provide freeze protection. The pump(s) and blower will run either continuously or periodically depending on conditions.

In colder climates, an optional additional freeze sensor may be added to protect against freeze conditions that may not be sensed by the standard sensors. Auxiliary freeze sensor protection acts similarly except with the temperature thresholds determined by the switch. See your dealer for details.

### Clean-up Cycle (optional)

When a pump or blower is turned on by a button press, a clean-up cycle begins 30

minutes after the pump or blower is turned off or times out. The pump and the ozone generator will run for 30 minutes or more, depending on the system. On some systems, you can change this setting.

## TEMPERATURE & TEMP RANGE

### Adjusting the Set Temperature

Pressing Up or Down temperature buttons will cause the temperature to flash. Pressing a temperature button again will adjust the set temperature in the direction indicated on the button. When the LCD stops flashing, the spa will heat to the new set temperature.

### Press-and-Hold

If a Temperature button is pressed and held when the temperature is flashing, the temperature will continue to change until the button is released.

### Dual Temperature Ranges

This system incorporates two temperature range settings with independent set temperatures. The High Range designated in the display by an "up" arrow, and the Low Range designated in the display by a "down" arrow. These ranges can be used for various reasons, with a common use being a "ready to use" setting vs. a "vacation" setting.

The Ranges are chosen using the menu structure below. Each range maintains its own set temperature as programmed by the user. This way, when a range is chosen, the spa will heat to the set temperature associated with that range.

For example:

High Range may be set between 80°F - 104°F.

Low Range may be set between 50°F - 99°F.

Freeze Protection is active in either range.

## MODE - REST AND READY

In order for the spa to heat, a pump needs to circulate water through the heater. The pump that performs this function is known as the "heater pump." The heater pump can be either a 2-Speed Pump 1 or a circulation pump.

If the heater pump is a 2-Speed Pump 1, **READY** Mode will circulate water every 1/2 hour, using Pump 1 Low, in order to maintain a constant water temperature, heat as needed, and refresh the temperature display. This is known as "polling."

**REST** Mode will only allow heating during programmed filter cycles. Since polling does not occur, the temperature display may not show a current temperature until the heater pump has been running for a minute or two.

### Circulation Mode

If the spa is configured for 24HR circulation, the heater pump generally runs continuously. Since the heater pump is always running, the spa will maintain set temperature and heat as needed in Ready Mode, without polling. In Rest Mode, the spa will only heat to set temperature during programmed filter times, even though the water is being filtered constantly when in Circulation Mode.

### Ready-in-Rest Mode

READY/REST appears in the display if the spa is in Rest Mode and Jet 1 is pressed. It is assumed the spa is being used and will heat to set temperature. While Pump 1 High can be turned on and off, Pump 1 Low will run until set temperature is reached, or 1 hour has passed. After 1 hour, the System will revert to Rest Mode. This mode can also be reset by entering the Mode Menu and changing it.

## SHOW & SET TIME-OF-DAY

Setting the time-of-day can be important for determining filtration times and other background features. From the main menu, activate the temperature flashing. While the temperature is flashing, press "Light" repeatedly until "TIME" is displayed on the screen. Proceed to set current time using the up and down temperature buttons. When in the TIME menu, SET TIME will flash on the display if no time-of-day is set in the memory. 24-hour time display can be set under the PREF menu.

**Note:** If power is interrupted to the system, Time-of-Day is not stored. The system will still operate and all other user settings will be stored. If filter cycles are required to run at a particular time of day, resetting the clock will return the filter times to the actual programmed periods. When the system starts up, it defaults to 12:00 Noon, so another way to get filter times back to normal is to start up the spa at noon on any given day. SET TIME will still flash in the TIME Menu until the time is actually set, but since the spa started at noon, the filter cycles will run as programmed.

## FLIP (INVERT DISPLAY)

From the main screen, activate the temperature flashing. While the temperature is flashing, press "Light" repeatedly until "FLIP" is displayed on the screen. While "FLIP" is displayed, press either the up or down temperature button to invert the screen. Follow the same procedures to flip it back.

## RESTRICTING OPERATION

The control can be restricted to prevent unwanted use or temperature adjustments. From the main screen, activate temperature flashing. While temperature is flashing, press "Light" repeatedly until "LOCK" appears on the screen. Pressing the temperature up button allows you to toggle through "TEMP", "OFF" and "ON".

"TEMP" allows you to lock the temp./settings. "ON" allows you to lock all settings/functions. "OFF" does not lock the spa.

## UNLOCKING

This Unlock sequence may be used from any screen that may be displayed on a restricted panel. While pressing and holding the Temperature Up button, slowly press the Light button twice. "UNLK" will display on the screen and after a few seconds, will revert to main screen.

## ADJUSTING FILTRATION

### Main Filtration

Filter cycles are set using a start time and a duration. Start time is indicated by an "A" or "P" in the bottom right corner of the display. Duration has no "A" or "P" indication. Each setting can be adjusted in 15-minute increments. The panel calculates the end time and displays it automatically.

To enter filter cycles, activate temperature flashing and press the "Light" button repeatedly until the display reads "FLTR" (with a 1 in the bottom right corner). Pressing the Light button will bring you to the display "BEGN". The numbers flashing indicate numbers that can be changed. Scroll through with the up and down temperature buttons to choose

what time your filter cycle will start and press the Light button to make your choice. "RUN" "HRS" will be on the display next. Again, scroll through the numbers to choose the duration of your filter cycle.

### Filter Cycle 2 - Optional Filtration

Follow the same procedures under "FLTR" (with a 2 in the bottom right corner) to set up filter cycle 2.

It is possible to overlap Filter Cycle 1 and Filter Cycle 2, which will shorten overall filtration by the overlap amount.

### Purge Cycles

In order to maintain sanitary conditions, secondary Pumps and/or a Blower will purge water from their respective plumbing by running briefly at the beginning of each filter cycle. If Filter Cycle 1 is set for 24 hours, enabling Filter Cycle 2 will initiate a purge when Filter Cycle 2 is programmed to begin.

## WiFi-CONNECTIVITY

See pages 48-51 to read about your spa's Wi-Fi capabilities. Some spas are equipped with full Wi-Fi. See your dealer for details if you are unsure of what your spa should receive.





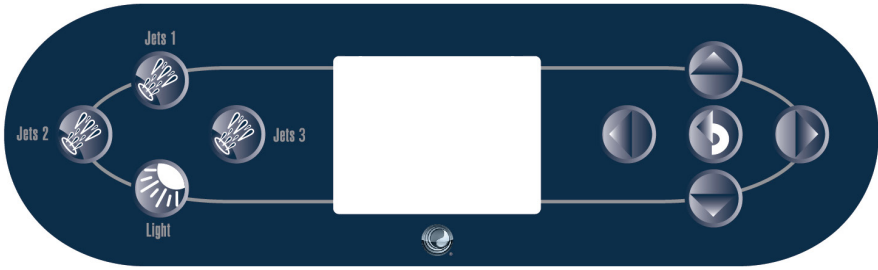

## GFCI TEST FEATURE

A GFCI is an important safety device and is required equipment on a hot tub installation. Your spa may be equipped with a GFCI Protection feature. If so, a GFCI Trip Test must occur to allow proper spa function. Within 7 days after startup, the spa will trip the GFCI to test it. The GFCI must be reset once it has tripped. After passing the GFCI Trip Test, the spa will operate normally.

# TP800 CONTROL PANEL



**NOTE:** The look of your topside control panel design and buttons will vary according to brand and features available on your spa. See table below for pictures and explanation of TP800 Control Panel button functions.

BUTTON	NAME	FUNCTION	BUTTON	NAME	FUNCTION
	Jets 1 Jets 2 Jets 3	Activates jets on low or high setting		Left Arrow	Allows for navigation through system
	Light	Activates lights		Right Arrow	Allows for navigation through system
	Up Arrow	Increases temperature and allows for navigation through system		Select	Allows user to go back or select an option.
	Down Arrow	Decreases temperature and allows for navigation through system			



## THE MAIN SCREEN

### SPA STATUS

Important information about spa operation can be seen quickly from the Main Screen. The most important features, including Set Temperature adjustment, can be accessed from this screen. The actual water temperature can be seen in large text and the desired, or Set Temperature, can be selected and adjusted. Time-of-day, Ozone operation and Filter Operation status is available, along with other messages and alerts. High Temperature Range vs. Low Temperature Range is indicated in the upper right corner. The Jets Icon in the center will light up if any pump is running and changes color when the heater is on. A Lock icon is visible if the panel or settings are locked. The Menu choices on the right can be selected and the screen will change to show more detailed controls or functions.

### NAVIGATION

Navigating the entire menu structure is done with 5 buttons on the control panel. When a text item changes to white during navigation, that indicates the item is selected for action. Operating or changing a selected item is generally done with the center or "Select" button. The only item that can be changed on the left side of the Main Screen is the Set Temperature. Press the Left Arrow button to change the Set Temperature number to white. The Set Temperature can then be adjusted with the up and down buttons. Pressing the Select button or the Right Arrow button will save the new set temperature. On the right side of the screen, the menu selections can be selected with the Up and Down Buttons. Use the Select Button to choose an item. Selecting one of these items will change to a different screen with additional controls.

### MESSAGES

At the bottom of the screen, messages may appear at various times. Some of these messages must be dismissed by the user.

### PRESS-AND-HOLD

If an Up or Down button is pressed and held when the Set Temperature is selected, the temperature will continue to change until the button is released, or the Temperature Range limits are reached.

## SPA & SHORTCUT SCREENS

### ALL EQUIPMENT ACCESS

The Spa Screen shows all available equipment to control, as well as other features, like Invert, in one easy-to-navigate screen. The display shows icons that are related to the equipment installed on a particular spa model. The navigation buttons are used to select an individual device. The device that is chosen is highlighted with a white outline and the text under the icon changes to white. Once a device is selected, it can be controlled using the center Select Button. Some devices have low and high settings which have different icons for low and high speed indicators. If the Spa has a Circ Pump, a Circ Pump Icon will appear to indicate its activity, but outside of Priming Mode, the Circ Pump cannot be controlled directly.

NOTE: The icon for the pump that is associated with the heater (Circ or P1 Low) will have a red glow in the center when the heater is running.

## ONE-PRESS ACTIVATION

The Shortcut Screen requires no navigation. Each button is fixed on a specific function and can be used as a very simple user interface for the spa.

## THE SETTINGS SCREEN

### PRESSING A “BUTTON”

When instructions are given to “press a button” any of the following can be done:

- Navigate to the desired item on any Screen. When the desired item is highlighted, press the Select Button.
- Press the button for that device while on the Shortcuts Screen, if the device is one of the 4 functions available.

### PROGRAMMING, ETC.

The Settings Screen is where all programming and other spa behaviors are controlled. This screen has several features that can be acted on directly. These features include Temp Range, Heat Mode, and Invert Panel. When one of these items is highlighted, the Select Button is used to toggle between two settings. All other menu items (with an arrow pointing to the right) go to another level in the menu.

### PRESS-AND-HOLD

If an Up or Down button is pressed and held when an item in a Menu List is highlighted, the list can be scrolled quickly from top to bottom. The scroll bar on the right side of the screen indicates the relative position of the highlighted item in the list.

### DUAL TEMPERATURE RANGES

This system incorporates two temperature range settings with independent set temperatures. The specific range can be selected on the Settings screen and is visible on the Main

Screen in the upper right corner of the display. These ranges can be used for various reasons, with a common use being a “ready to use” setting vs. a “vacation” setting.

Each range maintains its own set temperature as programmed by the user. This way, when a range is chosen, the spa will heat to the set temperature associated with that range.

High Range can be set between 80°F - 104°F.

Low Range can be set between 50°F - 99°F.

Freeze Protection is active in either range.

### HEAT MODE - READY VS. REST

In order for the spa to heat, a pump needs to circulate water through the heater. The pump that performs this function is known as the “heater pump.” The heater pump can be either a 2-speed pump (Pump 1) or a circulation pump. If the heater pump is a 2-Speed Pump 1, READY Mode will circulate water every 1/2 hour, using Pump 1 Low, in order to maintain a constant water temperature, heat as needed, and refresh the temperature display. This is known as “polling.” REST Mode will only allow heating during programmed filter cycles. Since polling does not occur, the temperature display may not show a current temperature until the heater pump has been running for a minute or two. While Pump 1 High can be turned on and off, Pump 1 Low will run until set temperature is reached, or 1 hour has passed.

### CIRCULATION MODE

If the spa is configured for 24HR circulation, the heater pump generally runs continuously. Since the heater pump is always running, the spa will maintain set temperature and heat as needed in Ready Mode, without polling. In Rest Mode, the spa will only heat to set temperature during programmed filter times, even though the water is being filtered constantly when in Circulation Mode.

## READY-IN-REST MODE

READY/REST appears in the display if the spa is in Rest Mode and the Jets 1 Button is pressed.

It is assumed that the spa is being used and will heat to set temperature. While Pump 1 High can be turned on and off, Pump 1 Low will run until set temperature is reached, or 1 hour has passed. After 1 hour, the System will revert to Rest Mode. This mode can also be reset by entering the Settings Menu and changing the Heat Mode.

## FILLING YOUR SPA

### PREPARATION AND FILLING

Fill the spa 5-6" below the lip of the spa. Be sure to open all valves and jets in the plumbing system before filling to allow as much air as possible to escape from the plumbing and the control system during the filling process. After turning the power on at the main power panel, the top-side panel will display a splash, or startup screen.

### PRIMING MODE

After the initial start-up sequence, the control will enter Priming Mode and display a Priming Mode screen. Only pump icons appear on the priming mode screen. The system will automatically return to normal heating and filtering at the end of the priming mode, which lasts 4-5 minutes. During the priming mode, the heater is disabled to allow the priming process to be completed without the possibility of energizing the heater under low-flow or no-flow conditions. Nothing comes on automatically, but the pump(s) can be energized by selecting the "Jet" buttons. Manually exit Priming Mode by pressing the "Exit" Button.

## PRIMING THE PUMPS

As soon as the Priming Mode screen appears on the panel, select the "Jets 1" button once to start Pump 1 in low-speed and then again to switch to high-speed. Also, select the other pumps to turn them on. The pumps should be running in high-speed to facilitate priming. If the pumps have not primed after 2 minutes, and water is not flowing from the jets in the spa, do not allow the pumps to continue to run. Turn off the pumps and repeat.

**Note:** Turning the power off and back on again will initiate a new pump priming session. Sometimes momentarily turning the pump off and on will help it to prime. Do not do this more than 5 times. If the pump(s) will not prime, shut off the power to the spa and call for service.

**Important:** A pump should not be allowed to run without priming for more than 2 minutes. Under NO circumstances should a pump be allowed to run without priming beyond the end of the 4-5 minute priming mode. Doing so may cause damage to the pump and cause the system to energize the heater and go into an overheat condition.

### EXITING PRIMING MODE

You can manually exit Priming Mode by navigating to the "Back" button on the Priming Mode Screen. If you do not manually exit the priming mode, it will terminate after 4-5 minutes. Once the system has exited Priming Mode, the top-side panel will display the Main Screen, but the display will not show the temperature yet because the system requires approximately 1 minute of water flowing through the heater to determine the water temperature.

## SPA BEHAVIOR

### PUMPS

On the Spa Screen, select a “Jets” button once to turn the pump on or off, and to shift between low- and high-speeds if equipped. If left running, the pump will turn off after a time-out period. The pump 1 low-speed will time out after 30 minutes. The high-speed will time-out after 15 minutes. On non-circ systems, the low-speed of pump 1 runs when the blower or any other pump is on. If the spa is in Ready Mode, Pump 1 low may also activate for at least 1 minute every 30 minutes to detect the spa temperature (polling) and then to heat to the set temperature if needed. When the low-speed turns on automatically, it cannot be deactivated from the panel, however the high speed may be started.

### CIRCULATION PUMP MODES

The circ pump operates continuously (24 hours) with the exception of turning off for 30 minutes at a time when the water temperature reaches 3°F (1.5°C) above the set temperature (most likely to happen in very hot climates).

### FILTRATION AND OZONE

On non-circ systems, Pump 1 low and the ozone generator will run during filtration. On circ systems, the ozone will generally run with the circ pump, but can be limited to filtration cycles. The system is factory-programmed with one filter cycle that will run in the evening (assuming the time-of-day is properly set) when energy rates are often lower. The filter time and duration are programmable. A second filter cycle can be enabled as needed. At the start of each filter cycle, the water devices like blower and other pumps will run briefly to purge the plumbing to maintain good water quality.

### FREEZE PROTECTION

If the temperature sensors within the heater detect a low enough temperature, then the water devices automatically activate to provide freeze protection. The water devices will run either continuously or periodically depending on conditions. In colder climates, an optional additional freeze sensor may be added to protect against freeze conditions that may not be sensed by the standard sensors. Auxiliary freeze sensor protection acts similarly except with the temperature thresholds determined by the switch. See your dealer for details.

### CLEAN-UP CYCLE (OPTIONAL)

When a pump or blower is turned on by a button press, a clean-up cycle begins 30 minutes after the pump or blower is turned off or times out. The pump and the ozone generator will run for 30 minutes or more.

### TIME-OF-DAY

Setting the time-of-day is important for determining filtration times and other background features. “Set Time” will appear on the display if no time-of-day is set in the memory. On the Settings Screen, select the Time-of-Day line. On the Time-of-Day screen, simply navigate right and left to select the Hour, Minutes, AM/PM and 12/24 Hour segments. Use the Up and Down Buttons to make changes.

### SAVING SETTINGS

The Time-of-Day screen is a simple, editable screen that illustrates a feature of the control that applies to all other editable screens as well. When changes are made, the icon to go “Back” changes to “Save” and a new icon for “Cancel” appears under the Save icon. Navigating to the left will highlight the Save icon, and

navigating down from there will allow the user to cancel the pending change. Pressing the "Select" button will save or cancel the changes and go back to the previous screen.

NOTE: If power is interrupted to the system, you may have to reset your spa's time.

## ADJUSTING FILTRATION

### MAIN FILTRATION

Using the same navigation and adjustment as Setting the Time, Filter Cycles are set using a start time and a duration. Each setting can be adjusted in 15-minute increments. The panel calculates the end time and displays it automatically.

### FILTER CYCLE 2 - OPTIONAL FILTRATION

Simply navigate to the Filter Cycle 2 line by pressing the Right Navigation Button, and when "NO" is highlighted, press Up or Down to toggle Filter Cycle 2 on and off. When Filter Cycle 2 is ON, it can be adjusted in the same manner as Filter Cycle 1 by navigating to the right. It is possible to overlap Filter Cycle 1 and Filter Cycle 2.

### CIRCULATION PUMP MODES

Some spas may be manufactured with Circ Pump settings that allow programming filtration cycle duration. Some circ Modes are pre-programmed to operate 24 hours a day and are not programmable.

### PURGE CYCLES

In order to maintain sanitary conditions, as well as protect against freezing, secondary water devices will purge water from their respective plumbing by running briefly at the beginning of each filter cycle.

If the Filter Cycle 1 duration is set for 24 hours, enabling Filter Cycle 2 will initiate a purge

when Filter Cycle 2 is programmed to begin.

## RESTRICTING OPERATION

The control can be restricted to prevent unwanted use or temperature adjustments. Locking the Panel prevents the controller from being used, but all automatic functions are still active. Locking the Settings allows Jets and other features to be used, but the Set Temperature and other programmed settings cannot be adjusted. Settings Lock allows access to a reduced selection of menu items. These include Set Temperature, Invert, Lock, Utilities, Information and Fault Log. They can be seen, but not changed or edited.

## UNLOCKING

An Unlock Sequence using the navigation buttons can be used from the Lock Screen. The Unlock Sequence is the same for both Panel Lock and Settings Lock. Press the following buttons: SELECT - SELECT - DOWN ARROW.

## WiFi-CONNECTIVITY

See pages 48-51 to read about your spa's Wi-Fi capabilities. Some spas are equipped with full Wi-Fi. See your dealer for details if you are unsure of what your spa should receive.

## GFCI TEST FEATURE

The Ground Fault Circuit Interrupter (GFCI) is an important safety device and is required equipment on a hot tub installation.

Used for verifying a proper installation, the GFCI Trip Test must occur to allow proper spa function. Within 7 days after startup, the spa will trip the GFCI to test it. The GFCI must be reset once it has tripped. After passing the GFCI Trip Test, the spa will operate normally.

## AUXILIARY PANEL

Selected models are equipped with an auxiliary control panel which allows you to operate pumps and the internal light without leaving the comfort of your seat.

### JETS 1

Touch the 'JETS 1' pad to activate the primary filtration pump. The sequence of the jet action is:

- 1 touch = Low therapy jets
- 2 touches = High therapy jets
- 3 touches = Off

### JETS 2

Touch the 'JETS 2' pad to activate the second therapy pump. The sequence of jet action is:

- 1 touch = High therapy jets
- 2 touches = Off



Auxiliary Control Panel

## THERAPY SEQUENCER

Certain models are equipped with a Jet Sequencer System that opens and closes a series of four solenoid valves to provide a therapeutic sequencing massage.

The control panel for the system allows you to start or stop operation, change programs, change speeds, or pause the system at any point in the program.

### Starting the Sequencer

To energize the sequencing system, press the 'JETS 3' button on the topside control panel. Once energized, the sequencer will open all 4 solenoid valves and water will flow through all open jets. Two dashed lines will be displayed in the LCD window.

Push the 'ON/OFF' button one time and the LCD display will now show 'On'. This indicates that the system has been activated, but no changes will occur until a sequencing program has been selected.

### Sequencing Programs

To start the sequencing program, push the 'PROG' button one time. The LCD will momentarily display 'P2', and then alternate between 'P2' and 'S1". The system is now running program 2 and sequencing speed 1. To change programs, push the 'PROG' button to step through the programs. The LCD will momentarily display the selected program (P3, P4, P5, etc.), and then alternately display the selected program with the sequencing speed. Refer to the chart on the next page to see the order in which the valves will open and close for each program.

## Sequencing Speeds

When first energized, the sequencing program will automatically go to the default speed, or 'S1'. To change the sequencing speed, push the 'SPEED' button once. The LCD will momentarily display the selected speed (S1, S2, or S3), and then alternately display the current program and the sequencing speed.

## Pausing

To pause the sequencing action of the system at any point, simply press the 'PAUSE' button. This will suspend the operation of the valves and hold them either until the sequence is resumed or until the system is de-energized. The LCD display will alternate between 'PA' and the current program number. Press the 'PAUSE' button again to resume normal operation.

Sequencer Chart on next page.



Jet Sequencer System

## Therapy Sequencer

ENGLISH

Program #	Valve	Sequence											
<b>P1</b> <i>Default</i>	V1	X	X	X	X	X	X	X	X	X	X	X	X
	V2	X	X	X	X	X	X	X	X	X	X	X	X
	V3	X	X	X	X	X	X	X	X	X	X	X	X
	V4	X	X	X	X	X	X	X	X	X	X	X	X
<b>P2</b>	V1	X				X				X			
	V2		X				X				X		
	V3			X				X				X	
	V4				X				X				X
<b>P3</b>	V1	X					X		X				
	V2		X				X		X				X
	V3			X		X				X		X	
	V4				X						X		
<b>P4</b>	V1	X		X		X		X		X		X	
	V2	X		X		X		X		X		X	
	V3		X		X		X		X		X		X
	V4		X		X		X		X		X		X
<b>P5</b>	V1	X		X		X		X		X		X	
	V2		X		X		X		X		X		X
	V3	X		X		X		X		X		X	
	V4		X		X		X		X		X		X
<b>P6</b>	V1	X		X		X		X		X		X	
	V2		X		X		X		X		X		X
	V3		X		X		X		X		X		X
	V4	X		X		X		X		X		X	
<b>P7</b>	V1	X		X		X		X		X		X	
	V2	X		X		X		X		X		X	
	V3	X		X		X		X		X		X	
	V4		X		X		X		X		X		X
<b>P8</b>	V1	X		X		X		X		X		X	
	V2		X		X		X		X		X		X
	V3		X		X		X		X		X		X
	V4		X		X		X		X		X		X
<b>P9</b> <i>Random</i>	V1	X					X			X			
	V2			X				X				X	
	V3		X			X					X		
	V4				X			X					X



# WiFi CONNECTIVITY

## Smart Device WiFi Spa Controls

Certain spas come factory equipped with a WiFi transceiver that allows them to connect wirelessly with select smart devices (Android™, iPad or iPhone®). (If you are not sure if your spa is equipped with a Wifi transceiver, please inquire with your local dealer.) If your WiFi-equipped spa is installed within range of your home's WiFi router, you may also connect your spa to the Internet to allow wireless control of your spa from anywhere your smart device accesses the Internet.

## Getting Started

Download the Wi-Fi Spa Control application to your smart device through either the Google® Play or iTunes® Store. Search for your spa brand's Wi-Fi Spa Control Application and the application will appear for download.

## After Application Download

Make sure your smart device's WiFi setting is on and that you are near your spa. Open your device's WiFi settings and find the BWG SPA network which will look similar to "BWG-Spa\_12345". Connect to this network. No password is required.

## Connect to your Spa

Start the newly downloaded application on your smart device. Choose "Connect" when prompted to connect to your spa and wait until you are connected.

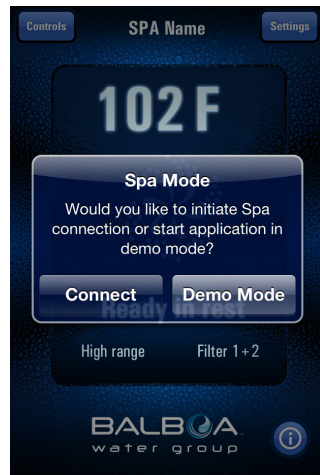
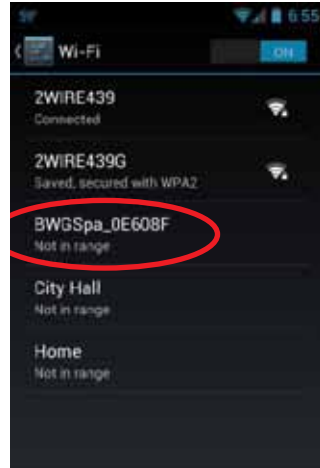

### Connecting to WiFi Network

Once you are connected to your spa, you can then connect your spa to your home WiFi network in order to control your spa from anywhere your smart device has access to the internet. To do this:

1. Open the main screen of the application
2. Choose "Settings" in the top right corner
3. Choose "Advanced" at the bottom center
4. Type in your home WiFi connection information and SAVE
5. Be sure to select Open, WEP, WPA or WPS based on your home Wi-Fi router's encryption type.

**Note: If you do not have a wireless internet connection in your home, you will not be able to connect with WiFi access.**

You will still be able to control the spa from your smart device within 30 feet (10 meters) of your spa.

### 1. Main Screen

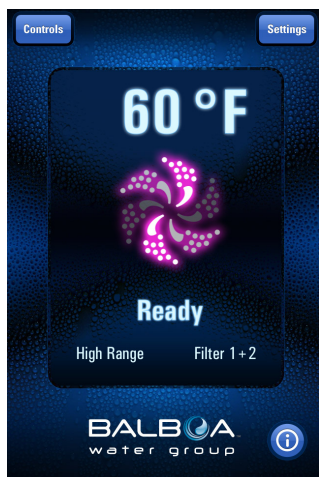

### 2. Setting Screen

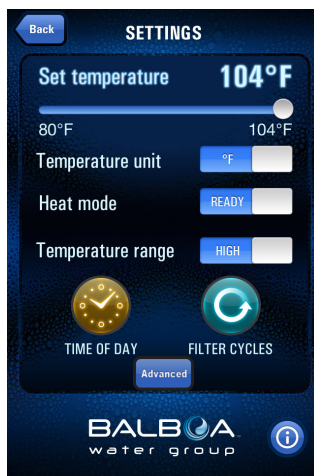

### 3. Advanced Setting Screen

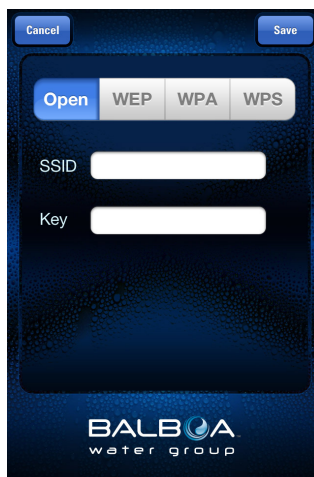

## Application Functions

You will be brought to the below main screen each time you start the app. The following options are available to you from the main screen:

**Settings** (top right)

**Controls** (top left)

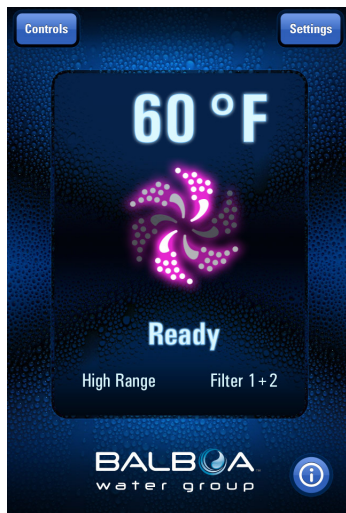

## Settings

Set the temperature by sliding the bar to the degree you want.

The “Temperature unit” setting allows you to toggle between displaying degrees in Fahrenheit or Celsius.

“Heat mode” allows you to toggle between READY and REST. READY indicates your spa’s controls can be turned on or off immediately. REST indicates your spa will have to “wake up” from sleep mode.

“Temperature range” offers a high temperature range option from 80-104°F (26-40°C) or a low temperature range option from 50-80°F (10-26°C). The temperature range on the top bar will change based on the range and unit of measurement you choose. (See photo on top of next column.)

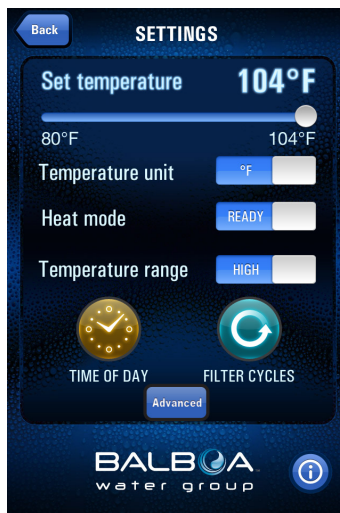

## Setting Time of Day

From the Settings menu, choose the Time of Day clock icon. On the next screen you can then set the time manually or choose Use Device Time. You can also choose to switch to 24 Hour Time.

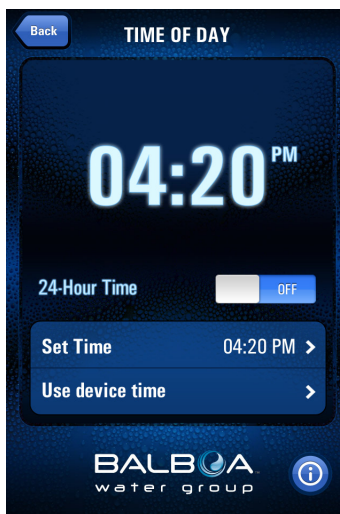

### Setting Filter Cycles

From the Settings menu choose the Filter Cycles icon. From there you will have the option to set one or two filter cycles, the time of day each starts and the duration of each cycle.

**Note: The recommended duration of filter cycles is twice a day, three hours per cycle.**

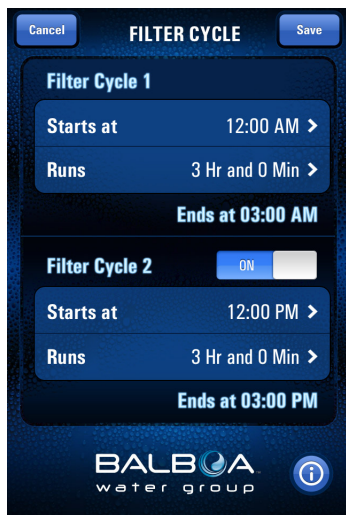

### Controls

From the main screen, choose Controls on the top left corner. You will be led to a screen which allows you to control the jets, blower and lights. Buttons that are lit up indicate items are in use, dimmed buttons indicate items are idle.



# EQUIPMENT SAFETY FEATURES

## Automatic Time Outs

Your Spa is equipped with an automatic Time Out feature designed to protect both the equipment and the user. For your safety and to reduce unnecessary use of the pumps and lights, the Time Out feature turns selected accessories off automatically, as follows:

Accessory	Mode	Shuts off in...
Pump 1	Low	2 hours
Pump 1	High	15 minutes
Pump 2	High	15 minutes
Pump 3	High	15 minutes
Blower		15 minutes
Lights		1 hour

## Common LCD Equipment Safety Messages

The following table describes the most common messages, possible causes, and corrective actions you may need to take:

If the LCD displays...	Indicates...	What happens...	Possible cause...	Corrective Action...
OHH	Overheat - one of the sensors has detected water temperature of 118°F+ (48°C+) inside the heater	Spa heater will automatically shut down until temperature falls below 108°F+ (42°C+)	<ul style="list-style-type: none"> <li>- Low speed pump operating for an extended period of time</li> <li>- Programming error causing continuous filtering</li> <li>- Faulty Pump</li> </ul>	<ul style="list-style-type: none"> <li>- Make sure slice valves are open</li> <li>- Reprogram to ensure time cycles not overlapping</li> <li>- Contact dealer if problem persists</li> <li>- Open all jets</li> </ul>
OHS	Overheat - One sensor has detected temperature of spa water entering heater to be 110°F+ (43°C+)	Spa heater will automatically shut down until temperature falls below 108°F+ (42°C+)	<ul style="list-style-type: none"> <li>- Low speed pump operating for an extended period of time</li> <li>- Programming error causing continuous filtering</li> </ul>	<ul style="list-style-type: none"> <li>- Make sure slice valves are open</li> <li>- Reprogram to ensure time cycles not overlapping</li> <li>- Contact dealer if problem persists</li> <li>- Open all jets</li> </ul>
HFL	Heater flow problem	Heater will shut down while spa continues to function normally	<ul style="list-style-type: none"> <li>- Plugged filter</li> <li>- Low water</li> </ul>	<ul style="list-style-type: none"> <li>- Remove filter and clean</li> <li>- Add water</li> <li>- Contact dealer</li> <li>- Open all jets</li> </ul>

If the LCD displays...	Indicates...	What happens...	Possible cause...	Corrective Action...
LF	Water flow problem - Persistent flow problem	Heater will shut down while spa continues to function normally	- Plugged filter - Low water	- Remove filter and clean - Add water - Contact dealer - Open all jets
drY	Lack of water to the heater	Heater will shut down while spa continues to function normally	- Slice valve closed - Blocked suction return/filter/skimmer	- Add water - Contact dealer - Open all jets/valves - Remove blockage
dr	Lack of water to the heater	Heater will shut down while spa continues to function normally	- Slice valve closed - Blocked suction return/filter/skimmer	- Add Water - Open all jets/valves - Remove blockage
SnT	Heater sensor A not functioning	Spa automatically deactivated	- Non-functioning sensor	- Contact dealer for replacement sensor
SnH	Heater sensor B not functioning	Spa automatically deactivated	- Non-functioning sensor	- Contact dealer for replacement sensor
SnS	Heater sensors are out of balance			- Contact dealer

## Common LCD Messages

The following table defines other messages you will frequently see on the LCD display:

Message...	What it is...	What it means...
Pr -OR- RUN/ PMPS/PURG/AIR/-- SLP	Priming mode	Spa is in normal Priming Mode operation
ECN	Sleep mode	Spa is in normal Sleep Mode operation
STD	Economy mode	Spa is in normal Economy Mode operation
ICE -OR- TOO COLD	Standard mode	Spa is in normal Standard Mode operation
--	Freeze condition	Heater will come on to keep water above 45°F
WATR TOO HOT	Water temperature	Current water temperature not measured
	Water temperature	Spa water is too hot, functions disabled

# MAINTENANCE

## Water Chemistry

Water chemistry is critical in a spa system. Chemicals are used to sanitize the water and control the pH balance. The combination of high water temperature and small water volume means that the chemical balance must be watched carefully. It is recommended that you purchase a chemical start up kit, and the additional chemicals needed to maintain the proper/optimum chemical balance, from your dealer.

## Sanitizing

Sanitizing the water destroys harmful organisms and keeps your spa healthy and safe. Three commonly used spa sanitizing or oxidizing agents are bromine, chlorine and ozone. Chlorine or bromine are chemicals that you add to the water. Ozone is a gas that is produced by an ozonator and injected into the water. It is important that a residual of sanitizer remain in your water. High water temperature, aeration and use will increase the need for sanitizer.

In addition to maintaining a residual, it is important to 'shock' your spa water periodically and after heavy use. This addition of substantial amounts of sanitizer super-chlorinates the water and oxidizes non-filterable organic residue. Allow the sanitizer level to drop back to the residual amount before using. Also use your Clean Up Cycle heavy use for additional filtration. Tests should be done daily with your test kit to keep a chlorine or bromine residual of 3.0 to 5.0 ppm.

## pH Level

pH is the balance of acidity and alkalinity in the water. Maintaining proper pH is

important for the effectiveness of your sanitizer, for user comfort, and to prevent corrosion of the spa equipment.

**Caution: Never** mix two chemicals together.

**Caution: Never** store chemicals in the equipment compartment.

**Caution: Do not use muriatic acid** to balance pH as it will damage your spa surface and equipment.

## Recommended Levels

pH:	7.2–7.6 (Ideal 7.4–7.6)
Sanitizer Residual:	3.5–5.0 ppm
Total Dissolved Solids:	100–200 ppm
Free Available Sanitizer:	3.0–5.0 ppm
Total Alkalinity:	80–100 ppm ideal for dichlor, trichlor, and bromine

**NOTE: Make sure you use fresh test kit strips/chemicals. Test kits and test chemicals should be stored in a cool, dry location. Check the manufacturer's instructions to determine shelf life and expiration date.**

## Water maintenance with the Ozone or UV Water Treatment System

Equipping your spa with an Ozone system that includes the Ozonator or UV Sanitizer is a smart decision. The use of ozone in conjunction with spa sanitizing and water balancing chemicals helps to provide you with a cleaner, healthier spa, reduces chemical usage, and protects your skin from chemically induced irritation.

## Sanitizing with Ozone

Spas vary in size, and frequency and conditions of use. For this reason you will need to establish your sanitizing program based upon your own personal use. When using ozone, you should start by balancing your water chemistry as you normally would. A spa should run and be ozonated a minimum of four hours per day. If your spa is heavily used, this run time should be increased. Your spa produces ozone during the filtration cycles. The amount of a residual sanitizer (chlorine or bromine) that you maintain in the water will also vary depending on use. It is recommended that you maintain a residual of 3.0-5.0 ppm. Periodically, and after periods of heavy use, it is necessary to 'shock' your spa with large amounts of sanitizer.

**NOTE: Extra filtration can be provided by manually starting a clean-up cycle. Turn Pump 1 on in low speed. The pump will operate for an extended period and then automatically turn off. The heater will also operate during this period if the controls are set in Standard or Ready mode.**

## Specialty Chemicals

While ozone and UV may significantly reduce the usage of specialty chemicals (chlorine and bromine), they are not a substitute for these chemicals. All chemicals should continue to be monitored, especially during periods of heavy usage and when changing or replenishing the spa water.

## Draining your Spa

**NOTE: Always turn the circuit breaker off when you drain your spa. Do not turn the spa heater back on until you have full flow coming from the jets for several minutes.** High concentrations of impurities caused by

water evaporation, body oils, perfumes, and other contaminants may accumulate in the spa and cannot be filtered out.

**NOTE: It is advisable to drain your spa and refill it with fresh water every six to eight weeks or more often, depending on the amount of use.**

All spas are equipped with both external and internal drains. The external drain is used for draining the spa. The internal drain(s) are used to remove water from internal hoses when winterizing your spa (See pg. 43) or if the water is severely contaminated.

**NOTE: Use a standard garden hose to direct the water to an appropriate disposal area.**

The **external** drain valve is located at the base of the spa below the side panel, usually on the front left corner of the spa. Remove the outer black cap and connect a garden hose to the fitting. Turn the ring on the back of the valve counter-clockwise until it stops, then pull out to open the valve. Water will begin to flow. When flow stops, push in the valve, turn ring clockwise until it stops, remove hose and replace the cap.

The **internal** drain hose(s) are located behind the front access panel under the spa. Remove the access panel screws and the access panel. Locate the drain hose(s). For each hose drain valve, remove the cap, attach the garden hose, and follow the same procedure as the external drain. Water will begin to flow. When all water has been evacuated, push the valve back in, turn the valve back clockwise until it stops. Remove garden hose and replace the cap. Repeat for each internal drain hose.



**NOTE: Do NOT attempt to use the pump to drain the spa.**

**NOTE: Close and replace caps on all drains prior to refilling the spa.**

**NOTE: When refilling the spa, you may need to bleed air from the system. Refer to Priming Your Spa for instructions.**

### Filter Maintenance

**NOTE: It is not necessary to drain the spa in order to clean the filter.**

The removable filter cartridge is located in the filter canister behind the skimmer.

The filter should be inspected/cleaned monthly during normal use, and more often when spa use is heavy.

Your filtration system may also include a First Filter, an additional filter that is placed on top of the skimmer basket and pressed into place. This filter aids the collection of microscopic organic matter, debris, hair, soap residue and body oils. To clean this filter, remove, rinse or soak in cartridge cleaner as directed, and reinstall. When First Filter is no longer white after cleaning, replace with a new filter. These can be purchased from your dealer.

**Keep the filter cartridge clean!** Clean the filter cartridge at least once every 90 days. A clogged filter decreases performance and degrades water quality.

To clean the filter cartridge:

1. Turn the pump off.
2. Remove skimmer lid on top of spa filter area.
3. Remove strainer basket
4. Remove filter cartridge from the filter canister by grasping the top and lifting upwards. Some filters are threaded on.
5. Soak filter in a commercial filter cleaner/

degreaser, available from your Elite Spa dealer, per manufacturer's instructions. Hose out filter cartridge or replace with new cartridge, if needed.

6. Place filter cartridge back into filter canister. When the spa is empty, the weir door may block the filter canister. You must hold it out of the way when reinstalling the cartridge. When the spa is full, the door will float so you will have easy access for installing the filter cartridge
7. Replace strainer basket and skimmer lid.
8. Turn the pump ON.

Replacing the filter cartridge annually is recommended to maintain optimum performance. Filter maintenance depends on usage.

### Winterizing

In cold climates where freezing temperatures occur, special care is required to prevent the possibility of damage to the spa and equipment due to freezing. If you plan on using your spa during cold months, be sure your pump and heater are in good working order. The spa shell has been insulated to provide efficient operation in cold weather areas.

**NOTE: If you elect not to drain your spa and the temperature is going to be below freezing for extended periods of time, it is best to operate the spa heater at the maximum high temperature (to 104°F (40°C), especially if there is a power outage threat. This will help keep the spa water from freezing if you have a power failure.**

If you do not intend to use your spa during the winter months and there is danger of freezing, use the following steps to winterize your spa:

1. Turn off all electrical power to the spa.
2. Drain spa and hoses of all water using the directions for Draining Your Spa. Open all unions, and remove drain plugs from bottom of pumps. If you cannot draw off all of the water (especially from hoses), add Recreational Vehicle antifreeze to the remaining water through the bottom of the skimmer and jets. If antifreeze is used, contact your dealer for advice.

**NOTE: Prior to refilling the spa, drain all antifreeze from spa and hoses using the instructions for Draining Your Spa. Carefully monitor chemicals until all antifreeze residue has dissipated.**

3. The filter should be drained, and the cartridge removed and cleaned.
4. Check to see that there is no water in the heater element chamber.
5. Clean your spa as directed in the following two sections on this page.
6. Cover your spa with a water-shedding, impenetrable cover.
7. For further information on blowing out the plumbing lines and winterising procedures, contact your local dealer.

### Spa Cabinet Care

The cabinets are made of a high quality alternative to wood that is virtually maintenance free, requiring no staining, sealing, or waxing. To clean the spa cabinet, rinse dirt and dust regularly with clear water. To remove stubborn dirt, grime, and mild discoloration, wash with a mild detergent and warm water.

**Never use abrasive cleaners.**

### Spa Surface Care and Cleaning

Your spa shell surface is made of acrylic. A minimum amount of care and cleaning will keep your spa looking new for years. Use a spa cleaner for residue and lime build-up at the water level of the spa surface. It may be necessary to lower the water level 5-7 cm (2-3") before cleaning to avoid polluting the spa. Cleaner can be applied to the acrylic surface with a soft cloth and wiped clean. Use a non-abrasive household cleaner to clean your spa shell or use a mild dishwashing detergent. Rinse well and dry with a clean cloth.

**NOTE: Do not allow the acrylic surface to come in contact with products such as acetone (nail polish remover), nail polish, dry cleaning solution, lacquer thinners, gasoline, pine oil, etc.**

Remove dust and dry dirt with a soft, damp cloth. Clean grease, oil, paint and ink stains with isopropyl (rubbing) alcohol. Avoid using razor blades or other sharp instruments that might scratch the surface.

**Protect spa finish - always keep cover on the spa when not in use.**

### Light Bulbs

The Spa light bulb is serviceable from the spa cabinet. Remove the side panel and insulation closest to the light; locate the bracket that holds the bulb. Turn the black bulb holder 90 degrees counter-clockwise. Pull bulb straight out and replace. Insert bulb holder back into bracket and turn 90 degrees clock-wise to secure.

# COMMON WATER PROBLEMS

Problem	Usual Cause	Solution
<b>Cloudy Water</b>	<ul style="list-style-type: none"> <li>- Inadequate filtration/ dirty filter</li> <li>- Excessive oils/organic matter</li> <li>- Improper sanitation/ bacteria</li> <li>- High pH and/or high alkalinity</li> </ul>	<ul style="list-style-type: none"> <li>- Check to make sure the filter is running properly; clean filter with a filter cleaner or degreaser</li> <li>- Shock the spa with a chlorine or bromine sanitizer, or other shock treatment product</li> <li>- Increase sanitizer level to balance water and shock if needed</li> <li>- Adjust pH; add appropriate sodium bisulfate product</li> <li>- Use clarifier</li> </ul> <p><b>NOTE: If using an ozone generator, consult with your dealer before using polymer based clarifiers</b></p> <ul style="list-style-type: none"> <li>- Depending on the severity, drain the spa completely, clean and refill</li> </ul>
<b>Water Odor</b>	<ul style="list-style-type: none"> <li>- Excessive organics or chloramines; insufficient free available sanitizer</li> <li>- Improper sanitation</li> <li>- Inadequate filtration</li> <li>- Low pH</li> </ul>	<ul style="list-style-type: none"> <li>- Shock the spa with a chlorine or bromine sanitizer/shock, or other shock treatment product</li> <li>- Increase sanitizer level to balance water; shock if needed</li> <li>- Check to make sure the filter is running properly; clean filter with a filter cleaner or degreaser</li> <li>- Raise pH with sodium bicarbonate product.</li> <li>- If metals are present, add chelating agent.</li> </ul>
<b>Chlorine Odor</b>	<ul style="list-style-type: none"> <li>- Too many chloramines/ insufficient free available chlorine</li> <li>- Low pH</li> </ul>	<ul style="list-style-type: none"> <li>- Shock the spa with a chlorine available chlorine sanitizer/shock, or non-chlorine shock treatment</li> <li>- Adjust pH; raise pH with sodium bicarbonate product</li> </ul>
<b>Bromine Odor/ Yellow Water</b>	<ul style="list-style-type: none"> <li>- Low pH</li> </ul>	<ul style="list-style-type: none"> <li>- Adjust pH; raise pH with sodium bicarbonate product</li> </ul>

Problem	Usual Cause	Solution
<b>Musty Odor</b>	- Bacterial or algae growth	- Shock spa with a chlorine or bromine sanitizer/shock, of equivalent shock treatment product. If problem is visible, drain, clean, refill and balance spa
<b>Foaming/ Scum Ring Around the tub</b>	- Build up of body oils, lotion and chemicals resulting from soap or detergent	- Skim foam off using your leaf net or drain and refill
<b>Algae</b>	- pH Imbalance - Low free chlorine or bromine	- Adjust pH - Shock with a chlorine or bromine
<b>Eye Irritation</b>	- Low pH - Insufficient free available chlorine	- Raise pH with sodium bicarbonate product - Shock with a chlorine sanitizer/shock or other shock treatment product
<b>Skin Irritation/ Rash</b>	- Unsanitary/polluted water - Soaking too long - Chemicals not balanced, excessive ozone	- Keep recommended sanitizer residual at all times; superchlorinate or use a nin-chlorine shock treatment - Soak for smaller intervals, such as 15 minutes - Correct chemical imbalance
<b>Scale</b>	- Too much calcium dissolved in water - pH and total alkalinity too high	- Add a scale control product. Adjust total alkalinity and pH levels by adding the appropriate sodium bisulfate product; for concentrated scale deposits - Drain spa, scrub the scale off, refill the spa and balance the water
<b>Erratic pH Test Results/Unusual pH Test Color</b>	- Sanitizer level too high - Old pH indicator dye	- Test the pH, when the sanitizer level is below 5 ppm - Replace the pH indicator dye

Problem	Usual Cause	Solution
<b>Sanitizer Dissipating Too Rapidly</b>	<ul style="list-style-type: none"> <li>- Excessive organics in water</li> <li>- Temperature too high</li> <li>- Low pH</li> <li>- Low pH corrosion of metal fixtures</li> <li>- Low calcium hardness</li> <li>- Low total alkalinity</li> </ul>	<ul style="list-style-type: none"> <li>- Increase shock dosage; add sanitizer; shower before entering spa</li> <li>- Reduce temperature</li> <li>- Raise pH with sodium bicarbonate product</li> <li>- Use chelating agent if metals are present. Keep proper pH level (7.2 to 7.6).</li> <li>- Use chelating agent if metals are present. Maintain minimum 150-200 ppm calcium hardness</li> <li>- Use chelating agent if metals are present. Maintain proper alkalinity for type of sanitizer used.</li> </ul>

**NOTE:** If your source water has a high metal or mineral content, a specialty chemical should be used to avoid staining or accumulation of deposits. These guidelines cover the most common water problems when operating a spa with ozone. Contact your dealer for further information regarding chemical control issues.

# COMMON HARDWARE PROBLEMS

Problem	Usual Cause	Solution
<b>System not operating</b>	<ul style="list-style-type: none"> <li>- House circuit breaker tripped or in OFF position</li> </ul>	<ul style="list-style-type: none"> <li>- Reset circuit breaker on house breaker panel</li> </ul>
<b>Heater not operating</b>	<ul style="list-style-type: none"> <li>- Water level too low</li> <li>- Heater mode not selected</li> <li>- No power to heater</li> <li>- Heater not operating</li> <li>- Jets are closed</li> </ul>	<ul style="list-style-type: none"> <li>- Add water to reach fill line on Weir door</li> <li>- Open all jets</li> <li>- Refer to temperature/heater functioning.</li> <li>- Check house circuit breaker</li> <li>- Contact dealer</li> </ul>
<b>Water not clean</b>	<ul style="list-style-type: none"> <li>- Clogged or blocked floor suction or skimmer</li> <li>- Filter clogged (dirty)</li> <li>- Poor water chemistry</li> <li>- Insufficient filtering time</li> <li>- Improper maintenance</li> <li>- High content of solids in water</li> </ul>	<ul style="list-style-type: none"> <li>- Clean floor suction/skimmer. Remove blockage</li> <li>- Clean or replace</li> <li>- See Maintenance section</li> <li>- Run filtration mode longer</li> <li>- Contact dealer</li> <li>- Use clarifier or drain and refill spa</li> </ul>
<b>Abnormal water usage</b>	<ul style="list-style-type: none"> <li>- Excessive evaporation and/or splashing</li> </ul>	<ul style="list-style-type: none"> <li>- Use spa cover and refill as necessary</li> </ul>
<b>Overheating</b>	<ul style="list-style-type: none"> <li>- High ambient temperature</li> </ul>	<ul style="list-style-type: none"> <li>- Contact dealer</li> </ul>
<b>Low water flow from jets</b>	<ul style="list-style-type: none"> <li>- Operating in FILTER mode-low speed</li> <li>- Clogged or blocked suction or skimmer</li> <li>- Dirty filter</li> <li>- Jets in OFF position</li> <li>- Slice valves closed</li> </ul>	<ul style="list-style-type: none"> <li>- Select hi-speed jets</li> <li>- Clean floor suction/skimmer. Remove blockage</li> <li>- Clean or replace</li> <li>- Open jets</li> <li>- Contact dealer</li> </ul>
<b>Noisy pump and motor</b>	<ul style="list-style-type: none"> <li>- Clogged floor suction or skimmer</li> <li>- Low water level</li> <li>- Damaged or worn motor bearings</li> </ul>	<ul style="list-style-type: none"> <li>- Clean floor suction/skimmer</li> <li>- Add water to normal water level (15cm below lip)</li> <li>- Contact dealer</li> </ul>

Problem	Usual Cause	Solution
<b>No water flow from jets</b>	<ul style="list-style-type: none"> <li>- Pump not primed</li> <li>- Adjustable jets turned off</li> <li>- House circuit breaker tripped, no power to system</li> <li>- Faulty pump or motor</li> <li>- Pump surges</li> <li>- Slice valves closed</li> </ul>	<ul style="list-style-type: none"> <li>- See Priming section</li> <li>- Turn on jets</li> <li>- Reset circuit breaker at house panel</li> <li>- Low water. Check level on Weir door</li> <li>- Contact dealer</li> </ul>
<b>Water leakage from under spa</b>	<ul style="list-style-type: none"> <li>- Check unions &amp; drain hoses</li> </ul>	<ul style="list-style-type: none"> <li>- Close or tighten as necessary</li> </ul>
<b>No air flow from jets</b>	<ul style="list-style-type: none"> <li>- Air control not open</li> <li>- Jet nozzle not seated properly</li> <li>- Jet nozzle missing</li> </ul>	<ul style="list-style-type: none"> <li>- Open control - Check jet nozzles</li> <li>- Inspect jets and replace as needed</li> </ul>
<b>Motor will not operate</b>	<ul style="list-style-type: none"> <li>- House circuit breaker tripped or in OFF position</li> <li>- Improper or defective wiring or electrical supply</li> <li>- Thermal Overload Protection switch tripped</li> </ul>	<ul style="list-style-type: none"> <li>- Reset circuit breaker</li> <li>- Contact dealer</li> <li>- Auto reset after motor has cooled. Contact dealer if motor continues to cycle</li> </ul>
<b>Black powder film around water line</b>	<ul style="list-style-type: none"> <li>- Wearing in of turbo/blower brushes</li> </ul>	<ul style="list-style-type: none"> <li>- Will disappear after use</li> </ul>
<b>The spa will not shut off</b>	<ul style="list-style-type: none"> <li>- Spa trying to heat</li> <li>- Spa is in filter cycle</li> <li>- Spa is in Standard or Ready Mode</li> </ul>	<ul style="list-style-type: none"> <li>- Check 'Set Temperature' in Standard Mode</li> <li>- Normal. No need to change</li> <li>- Check mode setting</li> </ul>

# SPA SOAKING GUIDELINES

---

1. Persons with heart disease, diabetes, blood pressure or circulatory abnormalities, a serious illness, or pregnant women should not enter a spa without prior consultation with their doctor.
2. People with skin, ear, genital or other body infections, open sores, or wounds should not use the spa because of the possibility of spreading infection.
3. Before entering, look at the water in your spa. If there is cloudiness, foaming, or if a strong chlorine smell is present, the water needs treatment. Properly maintained water will greatly reduce potential skin rash (pseudomonas) risk. Ask your authorized dealer for guidance.
4. Shower with soap and water before and after using the spa. Showering before use removes many common skin bacteria, perspiration, lotions, deodorants, creams, etc. that may reduce the effectiveness of the sanitizer and lessen the ability of the filter to work efficiently. Showering after use will help reduce skin irritation that may result from contact with spa chemicals.
5. Enter the spa slowly and cautiously. Be careful of your footing, and allow your body to gradually adjust to the water temperature. Exit slowly to accommodate relaxed leg muscles and possible light-headedness.
6. Soaking for too long may cause some users to feel nauseous, dizzy, or light-headed. If you wish to soak in high temperature water (104°F, 40°C), leave the spa after 15 minutes, shower, cool down and then return for another brief stay. In lower temperatures (e.g. 98.6°F, 37°C, normal body temperature) most people can comfortably and safely soak for longer periods at one sitting. If you have any questions about what's right for you, your family, or other guests, consult your doctor.
7. Be sure you check the water temperature before entering, and while using the spa.
8. Never use the spa while under the influence of alcohol.
9. Consult your doctor about potential harmful effects of using drugs or medications while hot water soaking.
10. **Never use the spa when you are alone.**
11. **Never allow children or elderly adults to use the spa unsupervised.**



# 300 SERIES SYSTEM WIRING DIAGRAM

ENGLISH

## Wiring Configuration and DIP Settings

### Setup 1 (As Manufactured)

- 120V Pump 1, 2-Speed
- 240V 4.0kW Heater (Approx. 1.0kW @ 120V)
- 12V Spa Light
- VL401, VL403, or VL406U Main Panel
- 120V Ozone

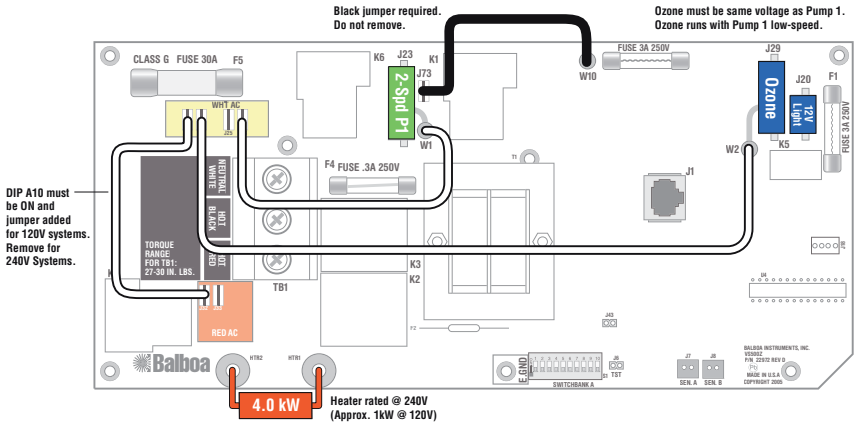

**WARNING:** Main Power to system should be turned OFF BEFORE adjusting DIP switches.  
**WARNING:** Persistent Memory (J43) must be RESET to allow new DIP switch settings to take effect. (See Persistent Memory page)

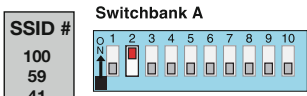

- |                              |                             |
|------------------------------|-----------------------------|
| A1, Test Mode OFF            | A6, 60 Hz                   |
| A2, P1, LT, TD, TU           | A7, Mode changes allowed    |
| A3, Duplex Panel             | A8, Degrees F               |
| A4, N/A (must be OFF)        | A9, P1-low timeout, Table 1 |
| A5, P1-high timeout, Table 1 | A10, High Amp mode          |



- Panel Button Assignments**
- 1=Pump 1
  - 2=Light
  - 3=Temp Down
  - 4=Temp Up

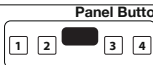

**Wiring Color Key**

- 120 Volt Connections
- 240 Volt Connections
- Black AC Jumpers
- 12 Volt Connections
- Relay Control Wires

**Board Connector Key**

- 1 Typically Line voltage
- 2 Typically Line voltage for 2-speed pumps
- 3 Neutral (Common)
- 4 Ground

Note flat sides in connector

# 501 SERIES SYSTEM WIRING DIAGRAM

ENGLISH

## Wiring Configuration and DIP Settings

### Setup 4 (As Manufactured)

- 240V Pump 1, 2-Speed
- 120V Ozone
- 12V Spa Light
- 120V AV (Hot)
- 240V 5.5kW Heater
- Duplex Main Panel

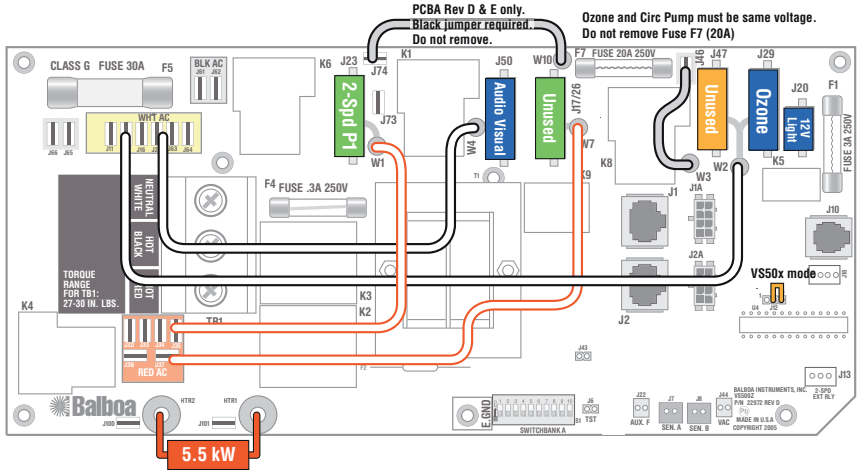

**WARNING:** Main Power to system should be turned OFF BEFORE adjusting DIP switches.  
**WARNING:** Persistent Memory (J43) must be RESET to allow new DIP switch settings to take effect. (See Persistent Memory page)

**SSID #**  
 67  
 63  
 51

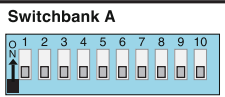

- |                          |                     |
|--------------------------|---------------------|
| A1, Test Mode OFF        | A6, 60 Hz           |
| A2, Mode changes allowed | A7, J17/26 Disabled |
| A3, Duplex Panel         | A8, Degrees F       |
| A4, Aux Freeze           | A9, Non-Circ Mode   |
| A5, 2-speed P1           | A10, High Amp mode  |

- Panel Button Assignments**
- |          |         |
|----------|---------|
| 1=J17/26 | 3=Temp  |
| 2=Pump 1 | 4=Light |

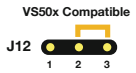
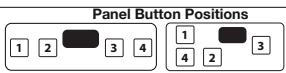

**Wiring Color Key**

- Black line: 120 Volt Connections
- Red line: 240 Volt Connections
- Blue line: 12 Volt Connections
- Orange line: Relay Control Wires

**Board Connector Key**

- Typically Line voltage
- Typically Line voltage for 2-speed pumps
- Neutral (Common)
- Ground

Note flat sides in connector



# MXBP20 SERIES SYSTEM WIRING DIAGRAM

## Hardware Setup

### Wiring Diagram

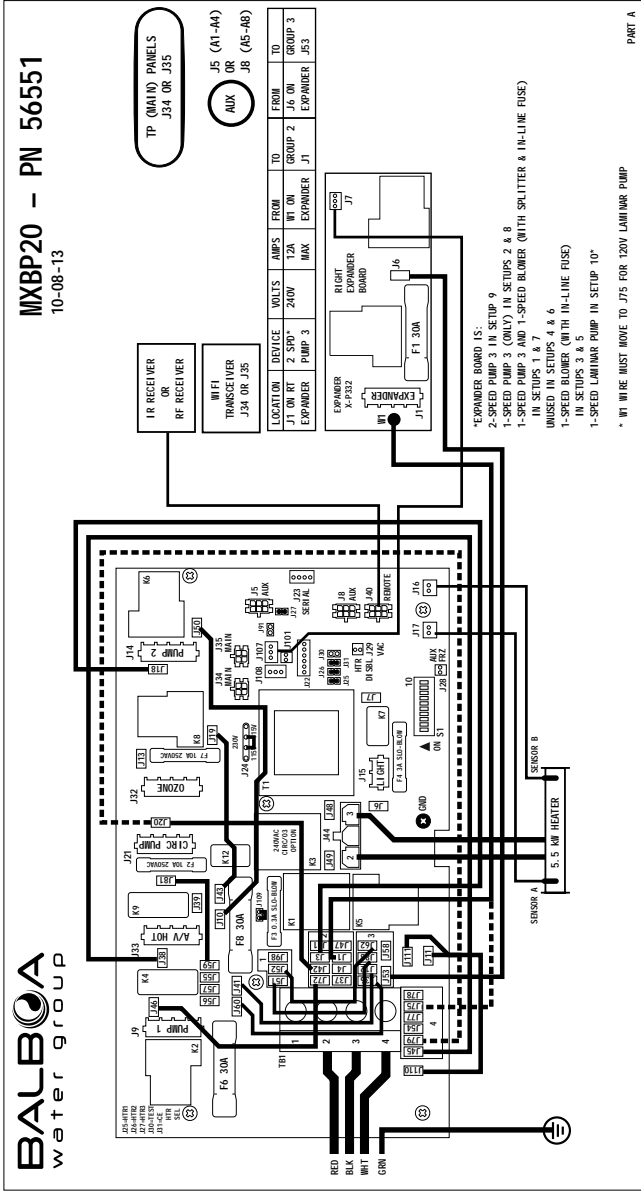

Manufactured under one or more of these patents. U.S. Patents: 5,332,944; 5,263,215; 5,559,720; 5,883,459; 6,253,227; 6,282,370; 6,591,086; 6,977,652; 6,965,815; 7,030,943; 7,447,854; bz. Canadian Patent: 2,342,814; Australian Patent: 2,373,446; other patents both foreign and domestic applied for and pending.

Copyright © 2009 Balboa Water Group.

Template 56377 10-05-12

# MXBP501 SERIES SYSTEM WIRING DIAGRAM

## Hardware Setup

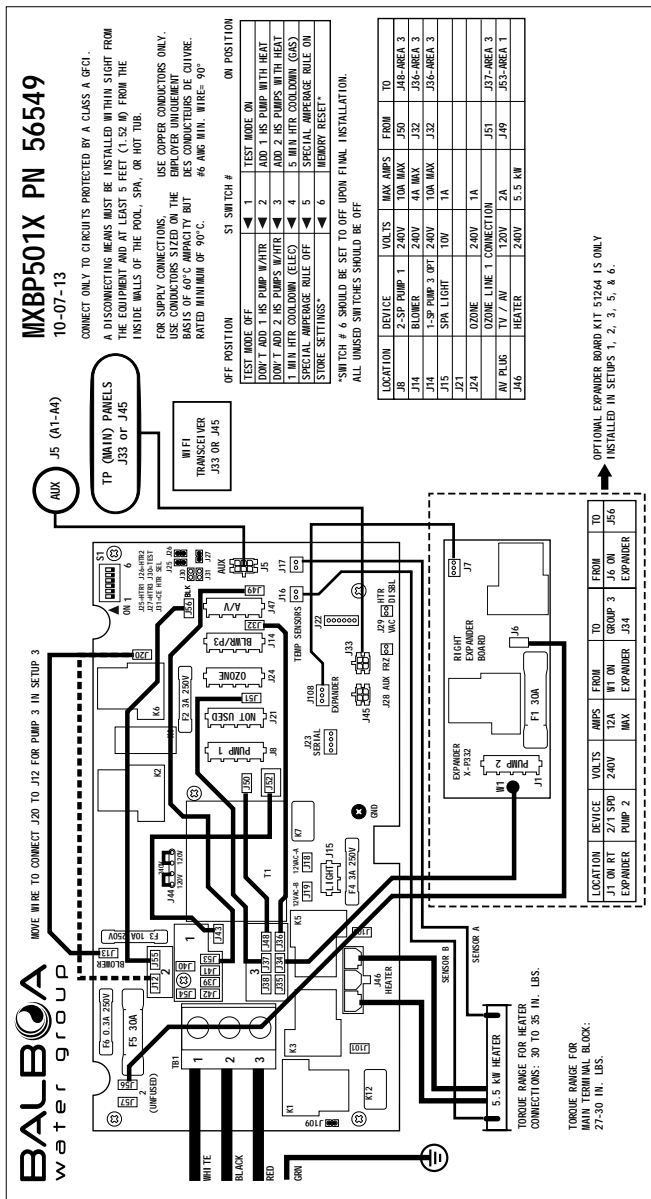

Manufactured under one or more of these patents: U.S. Patents: 5332944, 5381215, 5550153, 5559720, 5,883,459, 6293227, 6282370, 6590188, 6976052, 6965815, 7030343, 7,417,834 B2, Canadian Patent: 5426514, Australian patent: 2372548 other patents both foreign and domestic applied for and pending.

# SAFETY SIGN

---

The safety sign enclosed with your Owner's Manual should be permanently installed where visible to all users of the spa. This sign is adhesive backed and includes four screws for mounting the sign on rough surfaces. It is very important that you, as a spa owner, review the important safety instructions and warnings before you operate your spa. It is equally important that you instruct all users, even occasional ones, as to the warnings associated with spa use.

You may obtain additional signs by contacting :

USA: MAAX Spas Industries Corp..  
Customer Service  
25605 South Arizona Avenue  
Chandler, Arizona 85248  
[www.maaxspas.com](http://www.maaxspas.com)

## LIMITED WARRANTY SUMMARY

---

Please refer to the Warranty Card included with your product for complete warranty information. In order to receive prompt warranty service, you must return your warranty card, completed with model and serial number, to your dealer immediately upon completion of the spa installation. MAAX Spas Industries Corp. provides a limited warranty to our customers. It applies to the spa structure, surface, plumbing, pumps, heater, blower, and controls. The limited warranty does not cover damage resulting from improper maintenance, improper installation, misuse, abuse, accident, fire, normal wear and tear, or improper water maintenance. Unauthorized modifications of the spa may void the warranty. Replacement cost associated with transportation, removal and reinstallation are the sole responsibility of the spa owner. MAAX Spas Industries Corp., reserves the right to make changes in design or material of its products at any time without incurring liability. This limited warranty applies to the first retail purchaser and terminates upon any transfer of ownership.

# COPYRIGHTS AND TRADEMARKS

---

©Copyright 2014 MAAX Spas Industries Corp.. All rights reserved. No parts of this publication may be reproduced, stored in a retrieval system, or transmitted, in any form or by any means (electronic, mechanical, photocopying, recording or otherwise), without prior written permission.

**Disclaimer:**

The information in this manual is accurate to the best of MAAX Spas Industries Corp.'s knowledge. However, MAAX Spas Industries Corp. assumes no responsibility for errors or omissions. Nor is any liability assumed for damages resulting from use of the information contained herein. Specifications subject to change without notice. Spas shown at variable percentage of actual size.

**Congratulations on your purchase of a MAAX® Spas product. Your Owner's Manual provides installation, operation and maintenance instructions.**

**Please review it and keep it for future references.**

**Save These Instructions  
Owner's Record Information**

Date Purchases : \_\_\_\_\_

Purchased From : \_\_\_\_\_

Phone Number : \_\_\_\_\_

Installed By : \_\_\_\_\_

Serial Number : \_\_\_\_\_ Model : \_\_\_\_\_





Your MAAX Spas® dealer:

**MAAX**<sup>®</sup>  
**SPAS**  
INDUSTRIES CORP.

25605 South Arizona Avenue, Chandler, Arizona 85248  
©2014 MAAX Spas Industries Corp., Printed in U.S.A.



MEMBER

